



FRONTIER²⁰

M.P.D.

MULTI PATTERN
DESIGN

2025
EDITION

 **LANDMARK**
CERAMICS

FRONTIER²⁰

Frontier20 is a porcelain pavers collection perfectly suited for outdoor applications. The market's demand for a stain-proof, slip-resistant, chemical resistant, no maintenance product led to the development of a revolutionary aesthetically superior product, enough versatility for exteriors as well as interiors. Combining the highest level of quality control and technology with state-of-the-art equipment, age-old practices have been revitalized to offer a superior industry leading product. Frontier20 offers a dimension never seen before to your outdoor living area.



MULTI PATTERN DESIGN - M.P.D.	2	MULTI PATTERN DESIGN - BIG	12
THE DESIGN SOLUTION YOU WANT	4	MULTI PATTERN DESIGN - SMALL	34
MADE TO FIT EVERY SPACE	6	PRODUCT RANGE	42
MULTIPLE PATTERNS, ENDLESS POSSIBILITIES	8	TRIM TILES	82
INFINITE DESIGN SOLUTIONS FOR YOUR SPACE	10	TECHNICAL INFORMATION	94

A new landmark in the porcelain industry

Landmark Ceramics is an American company, based in Tennessee that has set out to research, manufacture and sell top quality porcelain ceramics in North America. Technological innovation, market presence, attention to detail, the welfare of people and the environment, efficient service and a thorough product range make Landmark a new benchmark in the North American market for those who are looking for a reliable partner for any building and architecture project using US made top quality porcelain material.

LEARN MORE ABOUT



M.P.D.

MULTI PATTERN DESIGN

The **Multi Pattern Design (M.P.D.)** is a project designed to allow combination of multiple size patterns and therefore develop creative and original outdoor design solutions. M.P.D. project is available in three different versions:

- **M.P.D. Big:** allows multiple big size patterns made by using 6 formats (24"x48", 12"x48", 24"x36", 24"x24", 12"x24", 12"x12").
- **M.P.D. Small:** combines 12"x12", 12"x24" and 24"x24" formats to create smaller size patterns.
- **M.P.D. Mini:** combines 9"x9" and 9"x18" to create refined and precious patterns.

PROJECT

OUTDOOR FLOOR DESIGN

Frontier20 Star Grey - 12"x48"
Frontier20 Star Grey - 12"x48"
Frontier20 Star Grey - 24"x24"
Frontier20 Star Grey - 12"x24"
Frontier20 Star Grey - 12"x12"
Frontier20 Arctic White - 12"x48"

THE DESIGN SOLUTION YOU WANT IN THE LOOK YOU LOVE.

_MPD is a vast and complete multi size design project, embracing various moods and a wide range of looks, from stone to wood, from marble to cement, from travertine to quartzite. Thanks to its broad and versatile range of looks, graphics and textures, Frontier20 is able to recreate the beauty of every detail from the material of inspiration, and mirror it in one of the dozens of design proposal included in its range. MPD is freedom to choose, because it offers infinite solutions, supporting the design you want to create by using the look you love.

**TRAVERTINE
LOOK**

**QUARTZ
LOOK**

**LIMESTONE
LOOK**

**STONE
LOOK**

**SLATE
LOOK**

**BLUESTONE
LOOK**

**MARBLE
LOOK**

**SLATE
LOOK**

MADE TO FIT EVERY SPACE.

Thanks to its high-technology and top-quality standard parameters, Frontier20 pavers used in any of the Multi-Pattern proposals are:

- _ Calibrated** - all pavers have a precise size and tolerance among different pieces are minimal (less than 0.5 mm).
- _ Modular** - every size is studied to be combined with all other sizes.
- _ Rectified** - every paver has straight and clean edges, for an easier installation and a cleaner and more refined final result.
- _ Uniform in thickness** - all pavers are very uniform in thickness, to allow an easy, precise, cost effective and worry-free installation whether in dry applications (on gravel, sand or gravel), on pedestals or when mortared down on a concrete base.

PROJECT

FLOOR DESIGN

Frontier20 Michelangelo Extra White - 24"x48"
Frontier20 Michelangelo Extra White - 12"x48"
Frontier20 Michelangelo Extra White - 24"x24"
Frontier20 Michelangelo Extra White - 12"x24"
Frontier20 Michelangelo Extra White Stair Tread - 12"x24"



MODULAR SIZES

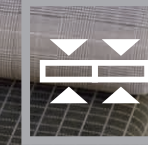

UNIFORM THICKNESS



RECTIFIED EDGES



MONO CALIBER

MULTIPLE PATTERNS, ENDLESS POSSIBILITIES, PURE DESIGN FREEDOM.

With Frontier 20 you have a broad and vast choice of authentic and beautiful looks, and from today, with MPD Project, you can also count on a broad range of sizes, easy to be combined together, for endless multi-size installation possibilities. Upgrade your projects and bring them to the next level!

MPD is pure design freedom, to be used almost anywhere, in **commercial** applications, such as public areas, as well as for **residential** installations, ensuring perfect balance between highest aesthetic requirements and technical performances, and always matching even the most demanding expectations.



BIG, SMALL OR MINI. INFINITE DESIGN SOLUTIONS FOR YOUR SPACE.

The Multi Pattern Design (M.P.D.) project is available in three different versions:

- **M.P.D. Big:** allows multiple big size patterns made by using 6 formats (24"x48", 12"x48", 24"x36", 24"x24", 12"x24", 12"x12").
- **M.P.D. Small:** combines 12"x12", 12"x24" and 24"x24" formats to create smaller size patterns.
- **M.P.D. Mini:** combines 9"x9" and 9"x18" to create refined and precious patterns.

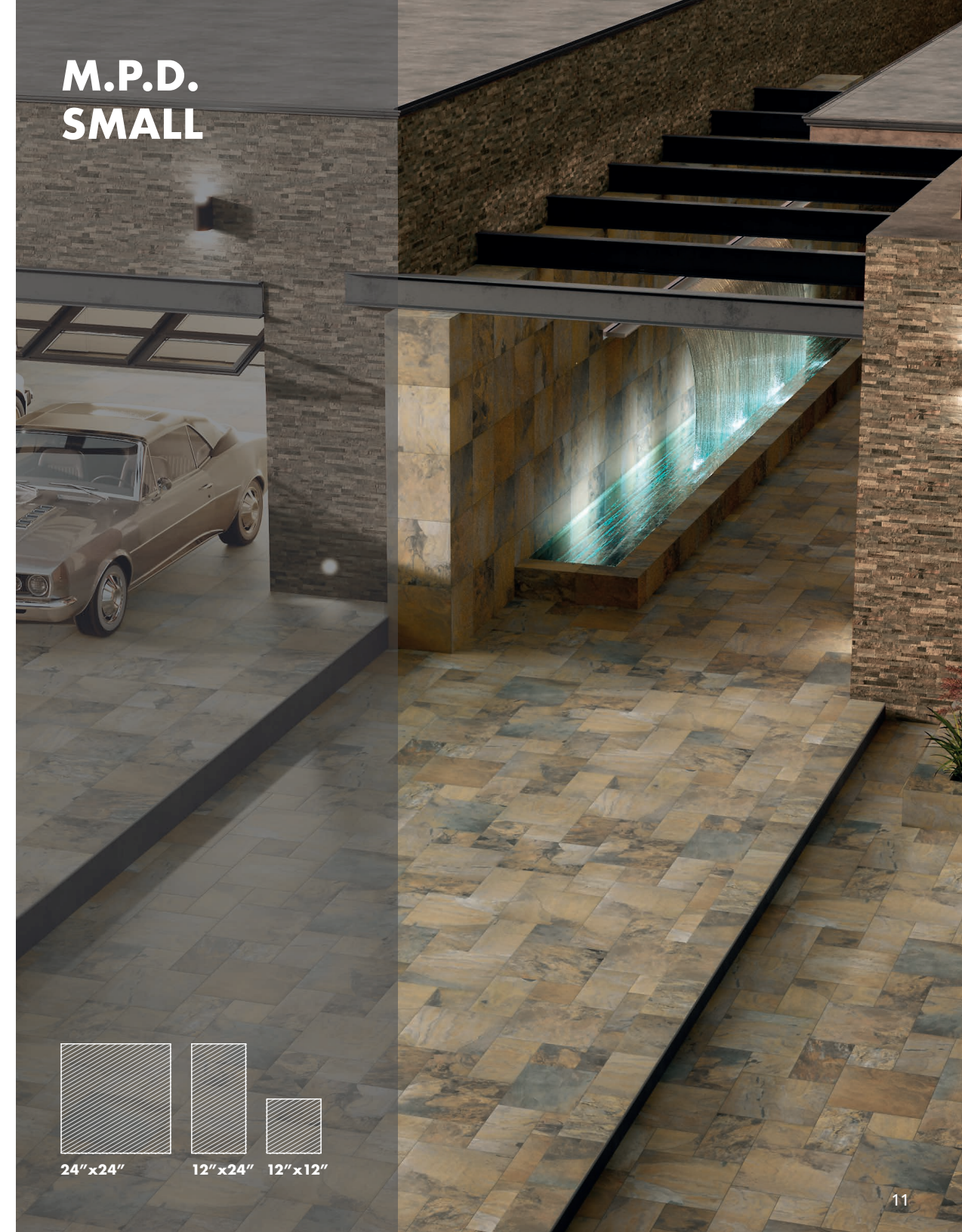

20MM THICKNESS
PORCELAIN PAVERS

MULTI PATTERN DESIGN BIG

PROJECT

OUTDOOR FLOOR DESIGN

- Frontier20 Travertine Cross Cut White - 24"x48"
- Frontier20 Travertine Cross Cut White - 24"x24"
- Frontier20 Travertine Cross Cut White - 12"x24"
- Frontier20 Travertine Cross Cut White - 12"x12"
- Frontier20 Travertine Cross Cut White Grip Stair Tread - 12"x24"
- Frontier20 Travertine Cross Cut White Riser - 8"x24"

WALL DESIGN

- Brick World Soho Black - 3"x12"
- Frontier20 Travertine Cross Cut White - 24"x48"

INDOOR FLOOR DESIGN

- Charme Calacatta Gold - 24"x48"

FLOWER BEDS

- Frontier20 Travertine Cross Cut White - 24"x48"

INDOOR FLOOR & WALL DESIGN

- Charme Calacatta Gold - 24"x48"



24" x 48"

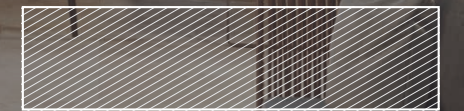

12" x 48"

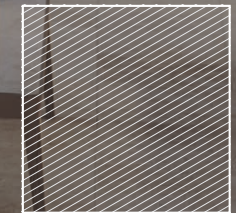

24" x 24"



12" x 24"



12" x 12"



24" x 36"

M.P.D. BIG ONE*



M.P.D. BIG TWO*



Module percentage

24"x48" = 40%
24"x24" = 20%
24"x36" + 12"x24"
(MIX) = 40% **

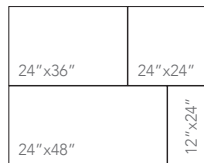

Available colors

- Bluestone Blue Select
- Bluestone Full color
- Travertine Cross Cut White
- Travertine Cross Cut Cream
- Travertine Cross Cut Silver
- Limestone
- Michelangelo Extra White
- Arctic White
- African Beige
- Star Grey
- Indiana Buff Select
- Indiana Grey Select
- Montauk White
- Montauk Grey
- Montauk Black



Module percentage

24"x48" = 50%
24"x36" + 12"x24"
(MIX) = 50% **

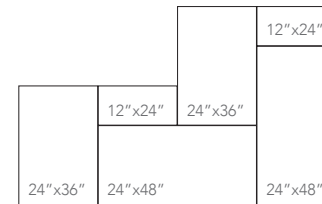

Available colors

- Bluestone Blue Select
- Bluestone Full color
- Travertine Cross Cut White
- Travertine Cross Cut Cream
- Travertine Cross Cut Silver
- Limestone
- Michelangelo Extra White
- Arctic White
- African Beige
- Star Grey
- Indiana Buff Select
- Indiana Grey Select
- Montauk White
- Montauk Grey
- Montauk Black



* Modular products with 6 mm joint (approx 1/4").
** NOTE: The 24"x36" and 12"x24" sizes (MIX) are palletized together on the same single pallet containing the correct percentages of each size.

* Modular products with 6 mm joint (approx 1/4").
** NOTE: The 24"x36" and 12"x24" sizes (MIX) are palletized together on the same single pallet containing the correct percentages of each size.

M.P.D. BIG THREE*



Module percentage

24"x48" = 40%
24"x24" = 20%
24"x36" + 12"x24"
(MIX) = 40% **



Available colors

- Bluestone Blue Select
- Bluestone Full color
- Travertine Cross Cut White
- Travertine Cross Cut Cream
- Travertine Cross Cut Silver
- Limestone
- Michelangelo Extra White
- Arctic White
- African Beige
- Star Grey
- Indiana Buff Select
- Indiana Grey Select
- Montauk White
- Montauk Grey
- Montauk Black



* Modular products with 6 mm joint (approx 1/4").
** NOTE: The 24"x36" and 12"x24" sizes (MIX) are palletized together on the same single pallet containing the correct percentages of each size.

M.P.D. BIG FOUR*



Module percentage

24"x24" = 67%
12"x24" = 33%

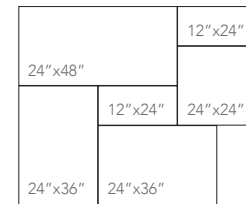

Available colors

- Bluestone Blue Select
- Bluestone Full color
- Travertine Cross Cut White
- Travertine Cross Cut Cream
- Travertine Cross Cut Silver
- Limestone
- Michelangelo Extra White
- Arctic White
- African Beige
- Star Grey
- Indiana Buff Select
- Indiana Grey Select
- Montauk White
- Montauk Grey
- Montauk Black



* Modular products with 6 mm joint (approx 1/4").
** NOTE: The 24"x36" and 12"x24" sizes (MIX) are palletized together on the same single pallet containing the correct percentages of each size.

M.P.D. BIG FIVE*

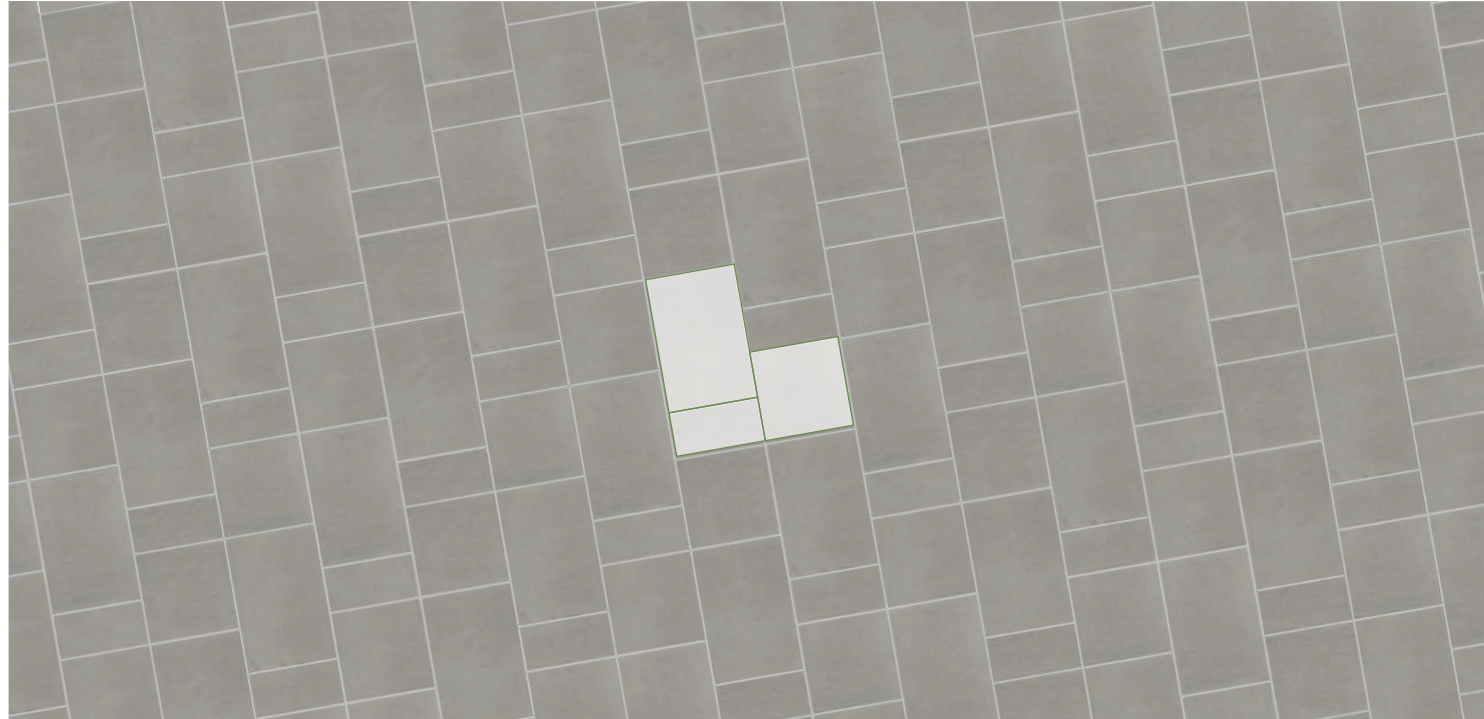

M.P.D. BIG SIX*



Module percentage

% HP1

24"x24" = 33%
24"x36" + 12"x24" (MIX) = 67% **

% HP2

24"x36" = 50%
24"x24" = 33%
12"x24" = 17%

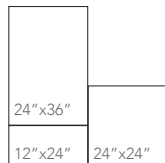

Available colors HP1

- Bluestone Blue Select
- Bluestone Full color
- Travertine Cross Cut White
- Travertine Cross Cut Cream
- Travertine Cross Cut Silver
- Limestone
- Michelangelo Extra White
- Arctic White
- African Beige
- Star Grey
- Indiana Buff Select
- Indiana Grey Select
- Montauk White
- Montauk Grey
- Montauk Black

Available colors HP2

- Thermal Bluestone Blue Select
- Thermal Bluestone Full Color

* Modular products with 6 mm joint (approx 1/4").

** NOTE: The 24"x36" and 12"x24" sizes (MIX) are palletized together on the same single pallet containing the correct percentages of each size.

Module percentage

% HP1

24"x24" = 45%
12"x12" = 11%
24"x36" + 12"x24" (MIX) = 44% **

% HP2

24"x36" = 33%
24"x24" = 45%
12"x24" = 11%
12"x12" = 11%

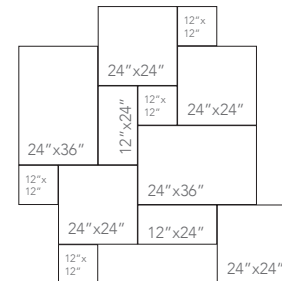

Available colors HP1

- Bluestone Blue Select
- Bluestone Full color
- Travertine Cross Cut White
- Travertine Cross Cut Cream
- Travertine Cross Cut Silver
- Limestone
- Michelangelo Extra White
- Arctic White
- African Beige
- Star Grey
- Indiana Buff Select
- Indiana Grey Select
- Montauk White
- Montauk Grey
- Montauk Black

Available colors HP2

- Thermal Bluestone Blue Select
- Thermal Bluestone Full Color

* Modular products with 6 mm joint (approx 1/4").

** NOTE: The 24"x36" and 12"x24" sizes (MIX) are palletized together on the same single pallet containing the correct percentages of each size.

M.P.D. BIG SEVEN*



Module percentage

% HP1

24"x24" = 31%
12"x12" = 8%
24"x36" + 12"x24" (MIX) = 61% **

% HP2

24"x36" = 46%
24"x24" = 31%
12"x24" = 15%
12"x12" = 8%

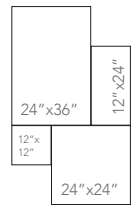

Available colors HP1

- Bluestone Blue Select
- Bluestone Full color
- Travertine Cross Cut White
- Travertine Cross Cut Cream
- Travertine Cross Cut Silver
- Limestone
- Michelangelo Extra White
- Arctic White
- African Beige
- Star Grey
- Indiana Buff Select
- Indiana Grey Select
- Montauk White
- Montauk Grey
- Montauk Black

Available colors HP2

- Thermal Bluestone Blue Select
- Thermal Bluestone Full Color

* Modular products with 6 mm joint (approx 1/4").

** NOTE: The 24"x36" and 12"x24" sizes (MIX) are palletized together on the same single pallet containing the correct percentages of each size.

M.P.D. BIG EIGHT*

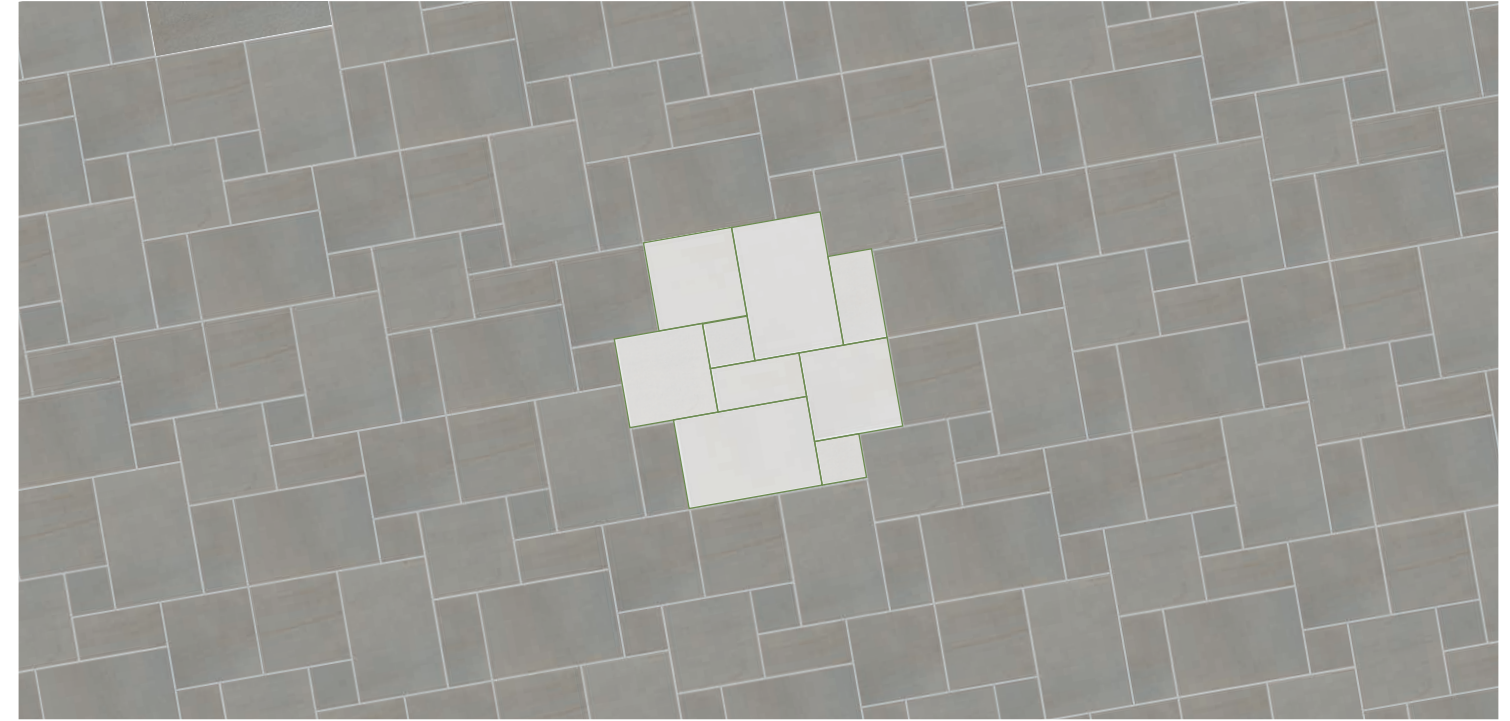

Module percentage

% HP1

24"x24" = 40%
12"x12" = 7%
24"x36" + 12"x24" (MIX) = 53% **

% HP2

24"x36" = 40%
24"x24" = 40%
12"x24" = 13%
12"x12" = 7%

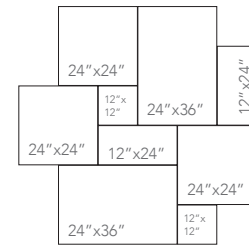

Available colors HP1

- Bluestone Blue Select
- Bluestone Full color
- Travertine Cross Cut White
- Travertine Cross Cut Cream
- Travertine Cross Cut Silver
- Limestone
- Michelangelo Extra White
- Arctic White
- African Beige
- Star Grey
- Indiana Buff Select
- Indiana Grey Select
- Montauk White
- Montauk Grey
- Montauk Black

Available colors HP2

- Thermal Bluestone Blue Select
- Thermal Bluestone Full Color

* Modular products with 6 mm joint (approx 1/4").

** NOTE: The 24"x36" and 12"x24" sizes (MIX) are palletized together on the same single pallet containing the correct percentages of each size.

M.P.D. BIG NINE*



M.P.D. BIG TEN*



Module percentage

- 24"x48" = 58%
- 12"x48" = 14%
- 24"x24" = 14%
- 12"x24" = 7%
- 12"x12" = 7%

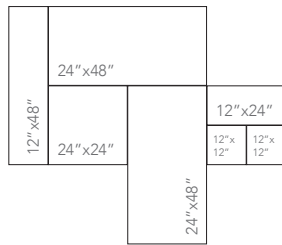

Available colors

- Bluestone Blue Select
- Bluestone Full color
- Travertine Cross Cut White
- Travertine Cross Cut Cream
- Travertine Cross Cut Silver
- Limestone
- Michelangelo Extra White
- Arctic White
- African Beige
- Star Grey
- Indiana Buff Select
- Indiana Grey Select
- Montauk White
- Montauk Grey
- Montauk Black

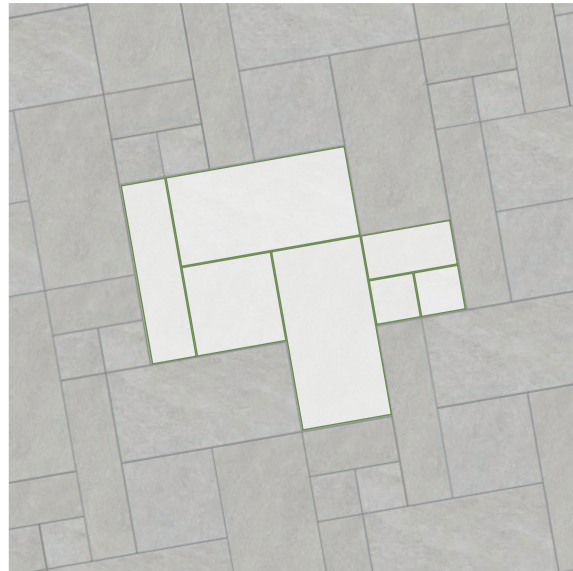

Module percentage

- 24"x48" = 58%
- 12"x48" = 14%
- 24"x24" = 14%
- 12"x24" = 14%

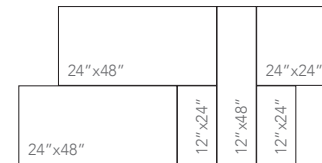

Available colors

- Bluestone Blue Select
- Bluestone Full color
- Travertine Cross Cut White
- Travertine Cross Cut Cream
- Travertine Cross Cut Silver
- Limestone
- Michelangelo Extra White
- Arctic White
- African Beige
- Star Grey
- Indiana Buff Select
- Indiana Grey Select
- White Avenue
- Cosmopolitan Ash
- Fashion Black
- Montauk White
- Montauk Grey
- Montauk Black

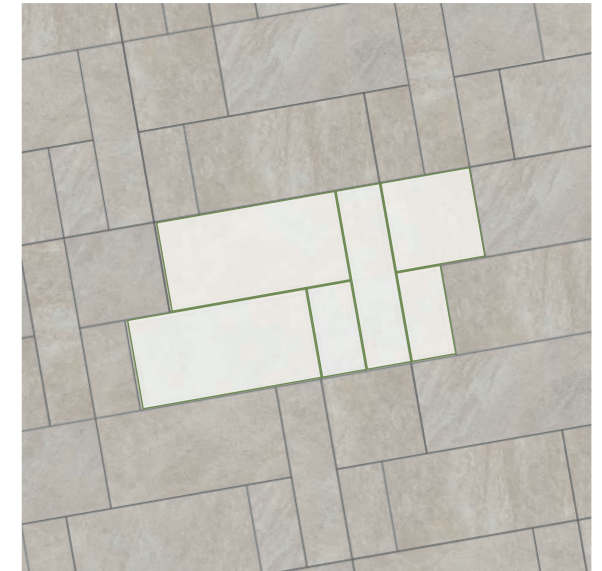

* Modular products with 6 mm joint (approx 1/4").

* Modular products with 6 mm joint (approx 1/4").

M.P.D. BIG ELEVEN*



M.P.D. BIG TWELVE*

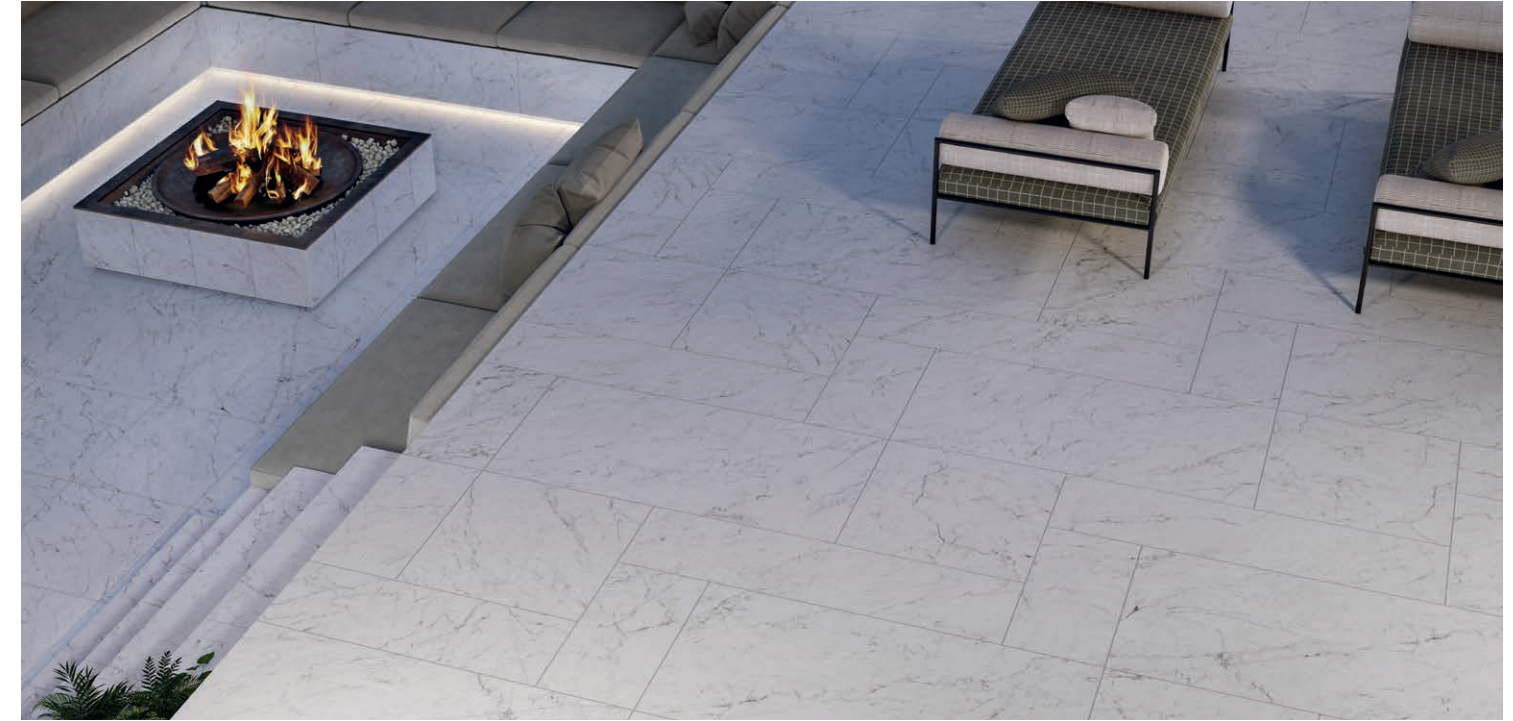

Module percentage

- 24"x48" = 31%
- 12"x48" = 15%
- 24"x24" = 31%
- 12"x24" = 15%
- 12"x12" = 8%

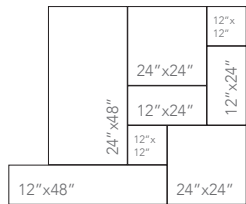

Available colors

- Bluestone Blue Select
- Bluestone Full color
- Travertine Cross Cut White
- Travertine Cross Cut Cream
- Travertine Cross Cut Silver
- Limestone
- Michelangelo Extra White
- Arctic White
- African Beige
- Star Grey
- Indiana Buff Select
- Indiana Grey Select
- Montauk White
- Montauk Grey
- Montauk Black



Module percentage

- 24"x48" = 22%
- 12"x48" = 45%
- 24"x24" = 22%
- 12"x24" = 11%

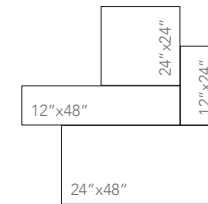

Available colors

- Bluestone Blue Select
- Bluestone Full color
- Travertine Cross Cut White
- Travertine Cross Cut Cream
- Travertine Cross Cut Silver
- Limestone
- Michelangelo Extra White
- Arctic White
- African Beige
- Star Grey
- Vintage Slab
- Indiana Buff Select
- Indiana Grey Select
- Montauk White
- Montauk Grey
- Montauk Black

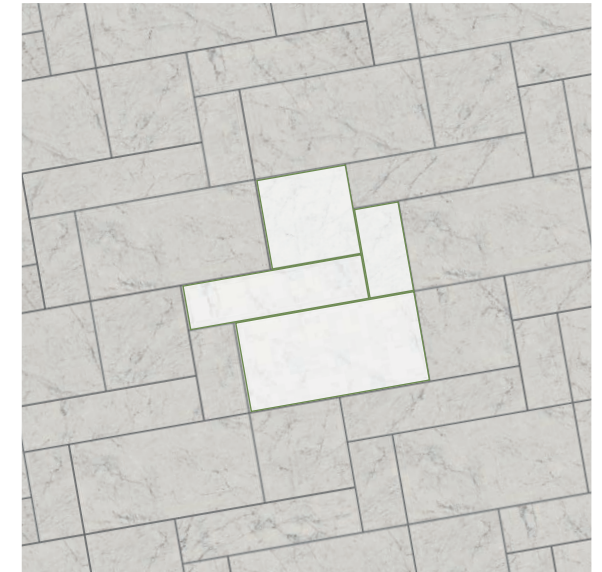

* Modular products with 6 mm joint (approx 1/4").

* Modular products with 6 mm joint (approx 1/4").

M.P.D. BIG THIRTEEN*



Module percentage

24"x48" = 62%
12"x48" = 30%
12"x12" = 8%

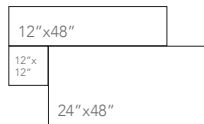

Available colors

- Bluestone Blue Select
- Bluestone Full color
- Travertine Cross Cut White
- Travertine Cross Cut Cream
- Travertine Cross Cut Silver
- Limestone
- Michelangelo Extra White
- Arctic White
- African Beige
- Star Grey
- Indiana Buff Select
- Indiana Grey Select
- Montauk White
- Montauk Grey
- Montauk Black

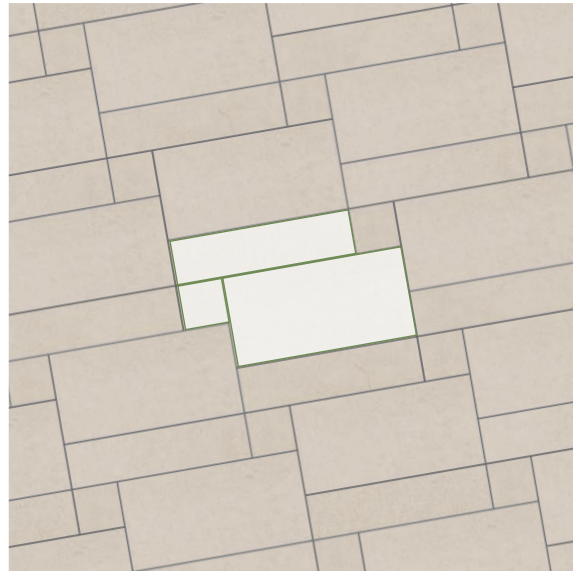

* Modular products with 6 mm joint (approx 1/4").

M.P.D. BIG FOURTEEN*



Module percentage

24"x48" = 67%
12"x48" = 33%

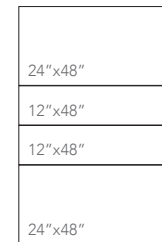

Available colors

- Bluestone Blue Select
- Bluestone Full color
- Travertine Cross Cut White
- Travertine Cross Cut Cream
- Travertine Cross Cut Silver
- Limestone
- Michelangelo Extra White
- Arctic White
- African Beige
- Star Grey
- Indiana Buff Select
- Indiana Grey Select
- White Avenue
- Cosmopolitan Ash
- Fashion Black
- Montauk White
- Montauk Grey
- Montauk Black



* Modular products with 6 mm joint (approx 1/4").

M.P.D. BIG FIFTEEN*



Module percentage

- 24"x48" = 38%
- 12"x48" = 19%
- 24"x24" = 19%
- 12"x24" = 19%
- 12"x12" = 5%

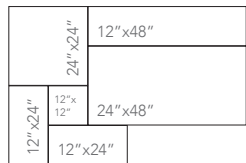

Available colors

- Bluestone Blue Select
- Bluestone Full color
- Travertine Cross Cut White
- Travertine Cross Cut Cream
- Travertine Cross Cut Silver
- Limestone
- Michelangelo Extra White
- Arctic White
- African Beige
- Star Grey
- Indiana Buff Select
- Indiana Grey Select
- Montauk White
- Montauk Grey
- Montauk Black

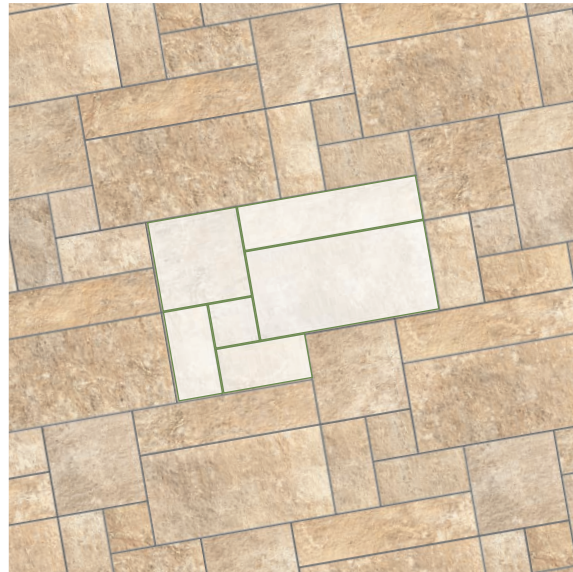

* Modular products with 6 mm joint (approx 1/4").

M.P.D. BIG SIXTEEN*



Module percentage

- 24"x48" = 31%
- 24"x24" = 31%
- 12"x24" = 23%
- 12"x12" = 15%

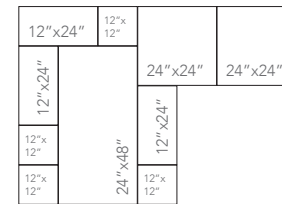

Available colors

- Bluestone Blue Select
- Bluestone Full color
- Travertine Cross Cut White
- Travertine Cross Cut Cream
- Travertine Cross Cut Silver
- Limestone
- Michelangelo Extra White
- Arctic White
- African Beige
- Star Grey
- Indiana Buff Select
- Indiana Grey Select
- Montauk White
- Montauk Grey
- Montauk Black

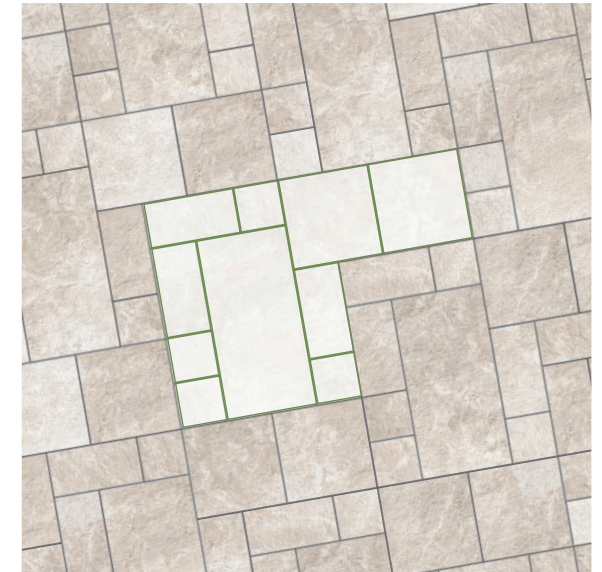

* Modular products with 6 mm joint (approx 1/4").

M.P.D. BIG SEVENTEEN*



M.P.D. BIG EIGHTEEN*



Module percentage

- 24"x48" = 33,5%
- 12"x48" = 33,5%
- 24"x24" = 17%
- 12"x24" = 8%
- 12"x12" = 8%

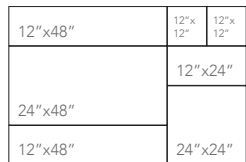

Available colors

-  Bluestone Blue Select
-  Bluestone Full color
-  Travertine Cross Cut White
-  Travertine Cross Cut Cream
-  Travertine Cross Cut Silver
-  Limestone
-  Michelangelo Extra White
-  Arctic White
-  African Beige
-  Star Grey
-  Indiana Buff Select
-  Indiana Grey Select
-  Montauk White
-  Montauk Grey
-  Montauk Black

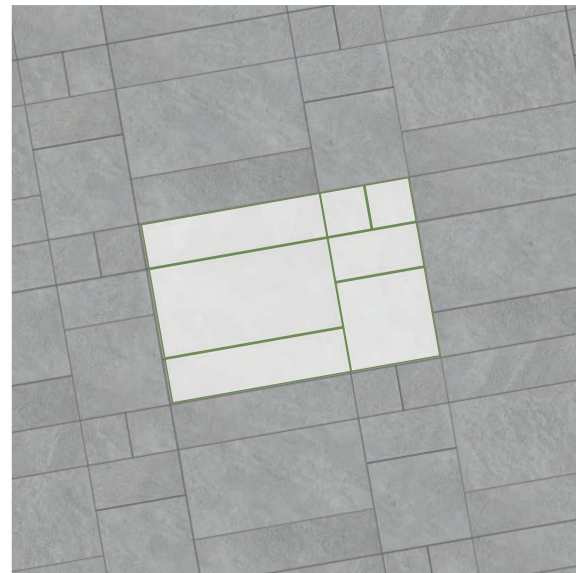

Module percentage

- 24"x48" = 50%
- 12"x48" = 50%

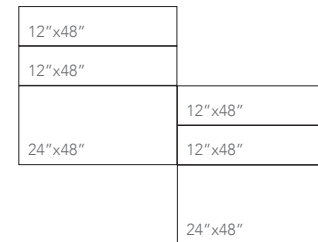

Available colors

-  Bluestone Blue Select
-  Bluestone Full color
-  Travertine Cross Cut White
-  Travertine Cross Cut Cream
-  Travertine Cross Cut Silver
-  Limestone
-  Michelangelo Extra White
-  Arctic White
-  African Beige
-  Star Grey
-  Indiana Buff Select
-  Indiana Grey Select
-  Montauk White
-  Montauk Grey
-  Montauk Black

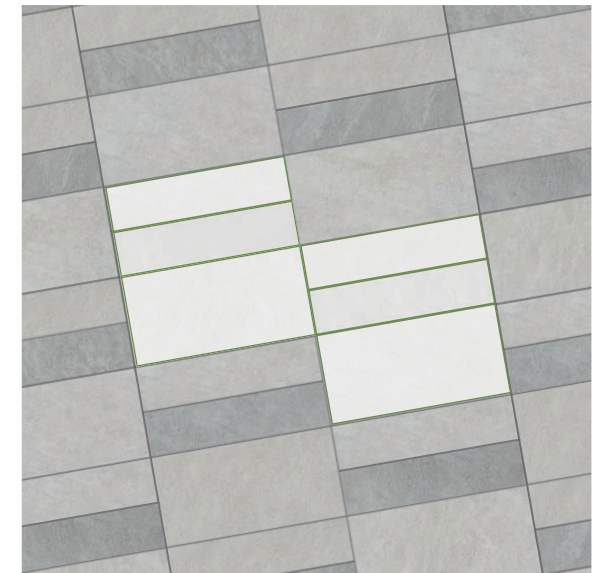

* Modular products with 6 mm joint (approx 1/4").

* Modular products with 6 mm joint (approx 1/4").

M.P.D. BIG NINETEEN*

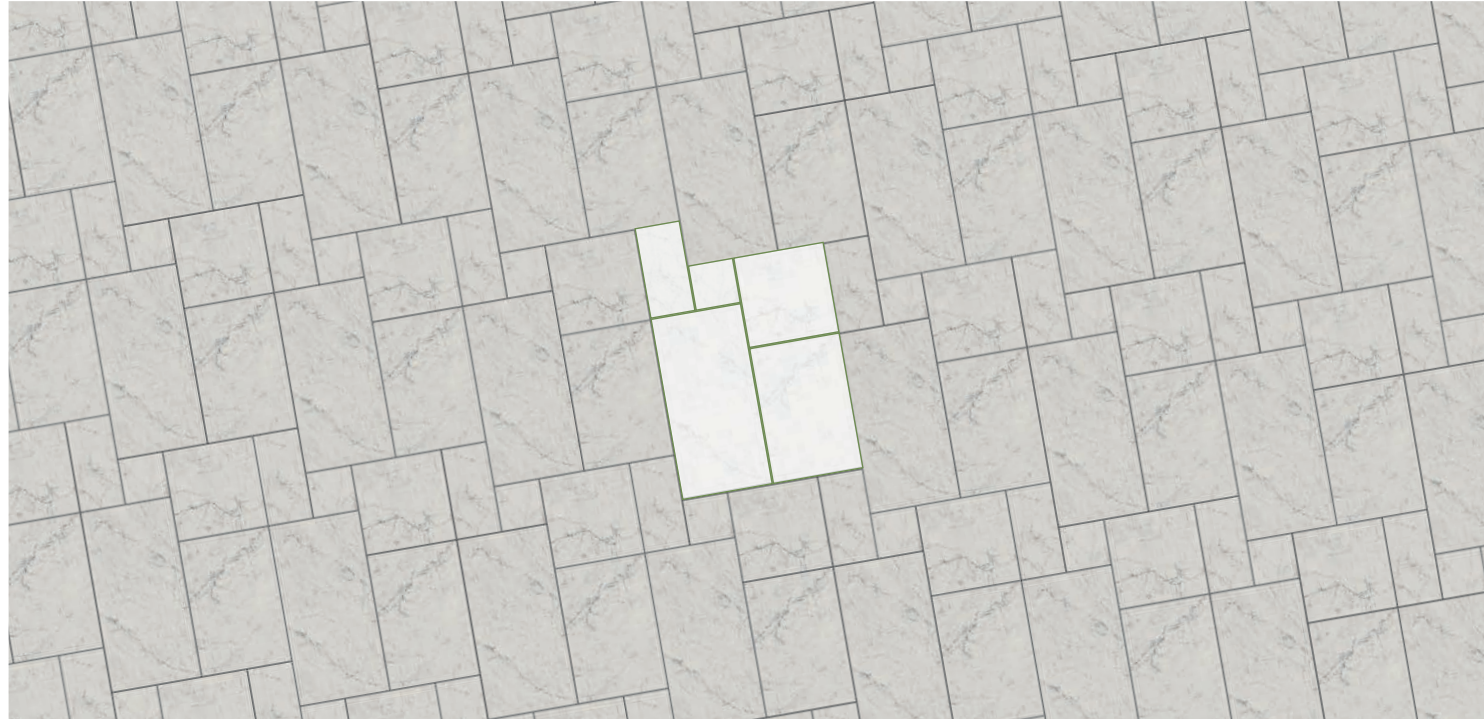

Module percentage

24"x48" = 38%
 24"x24" = 19%
 12"x12" = 5%
 24"x36" + 12"x24" (MIX) = 38% **

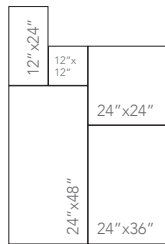

Available colors

- Bluestone Blue Select
- Bluestone Full color
- Travertine Cross Cut White
- Travertine Cross Cut Cream
- Travertine Cross Cut Silver
- Limestone
- Michelangelo Extra White
- Arctic White
- African Beige
- Star Grey
- Indiana Buff Select
- Indiana Grey Select
- Montauk White
- Montauk Grey
- Montauk Black

* Modular products with 6 mm joint (approx 1/4").
 ** NOTE: The 24"x36" and 12"x24" sizes (MIX) are palletized together on the same single pallet containing the correct percentages of each size.

M.P.D. BIG TWENTY*

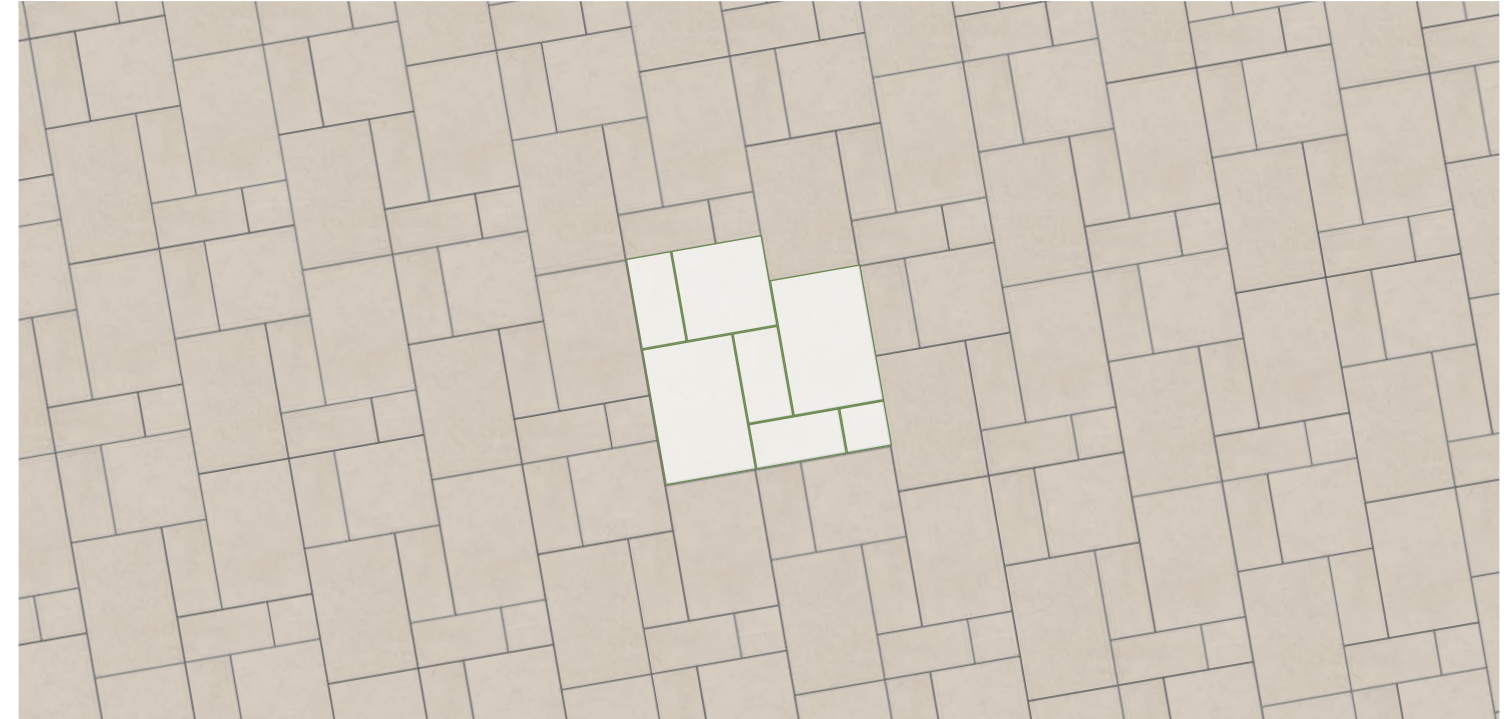

Module percentage

% HP1
 24"x24" = 18%
 12"x12" = 4%
 24"x36" + 12"x24" (MIX) = 78% **

% HP2
 24"x36" = 52%
 24"x24" = 18%
 12"x24" = 26%
 12"x12" = 4%

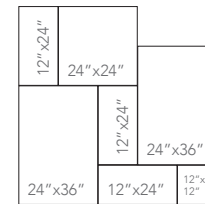

Available colors HP1

- Bluestone Blue Select
- Bluestone Full color
- Travertine Cross Cut White
- Travertine Cross Cut Cream
- Travertine Cross Cut Silver
- Limestone
- Michelangelo Extra White
- Arctic White
- African Beige
- Star Grey
- Indiana Buff Select
- Indiana Grey Select
- Montauk White
- Montauk Grey
- Montauk Black

Available colors HP2

- Thermal Bluestone Blue Select
- Thermal Bluestone Full Color

* Modular products with 6 mm joint (approx 1/4").
 ** NOTE: The 24"x36" and 12"x24" sizes (MIX) are palletized together on the same single pallet containing the correct percentages of each size.

20 THICKNESS
PORCELAIN PAVERS

**MULTI PATTERN
DESIGN**

SMALL

PROJECT
OUTDOOR FLOOR DESIGN
Frontier20 California Gold - 24"x24" - 12"x24" - 12"x12"
Frontier20 California Gold Trim Pieces
WALL DESIGN
Veneer World Pro LedgeStone Alpine Alaska - 6"x24"

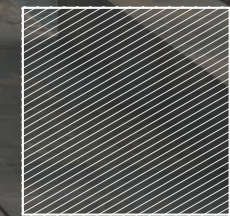

24" x 24"



12" x 24"



12" x 12"

M.P.D. SMALL ONE*

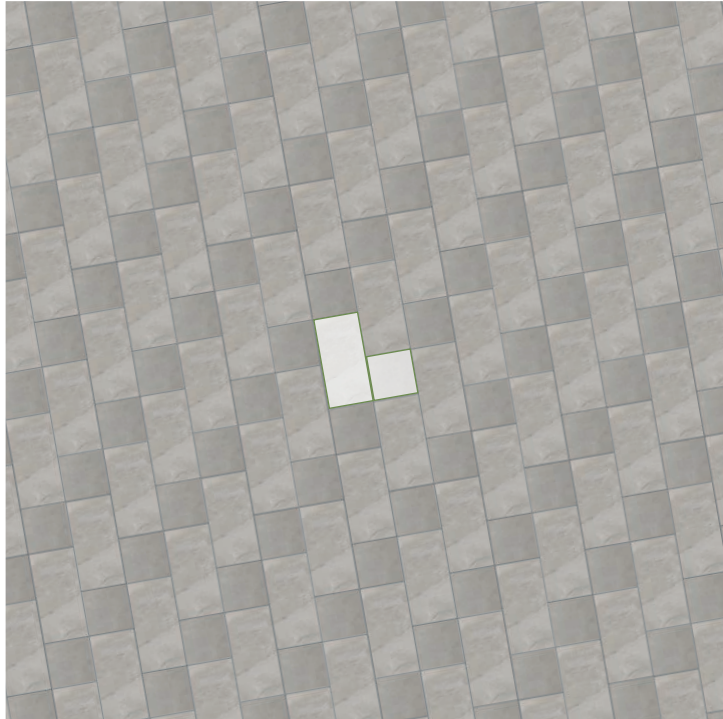

M.P.D. SMALL TWO*

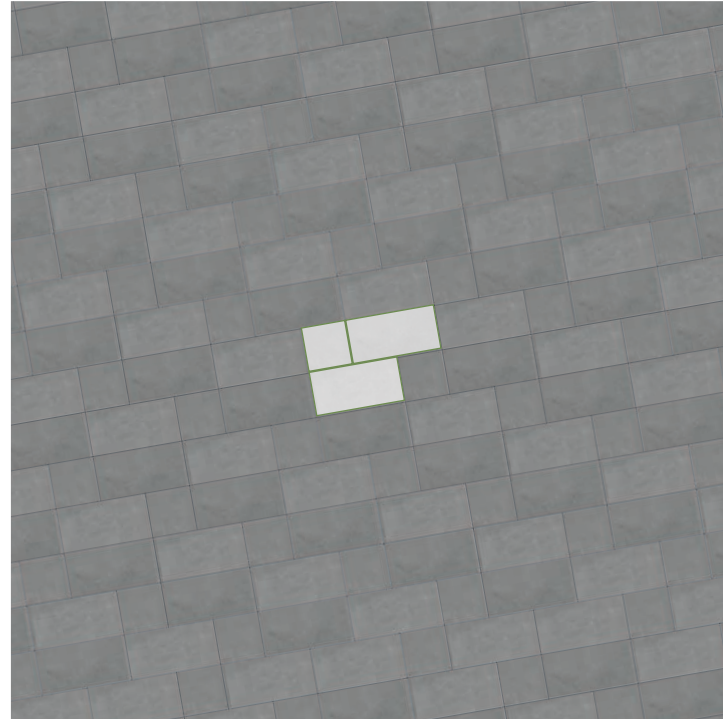

M.P.D. SMALL THREE*

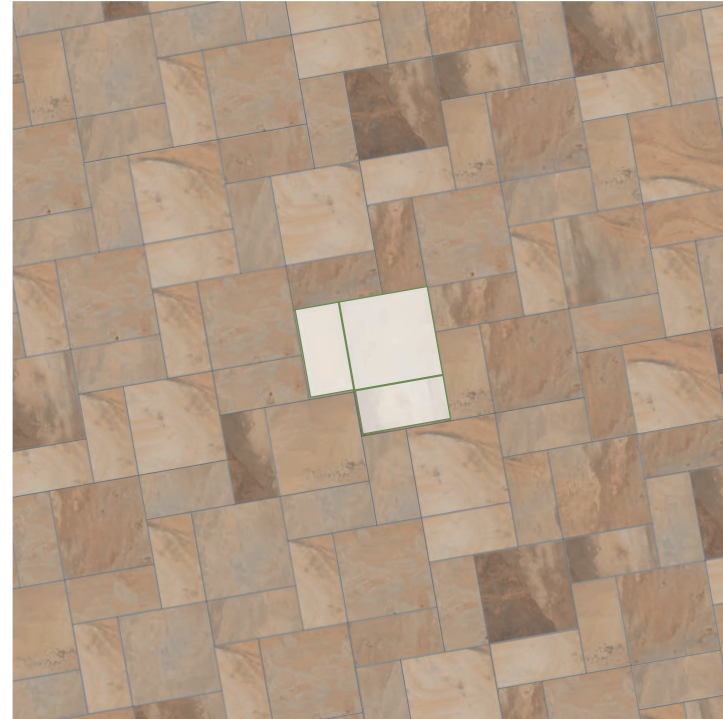

M.P.D. SMALL FOUR*

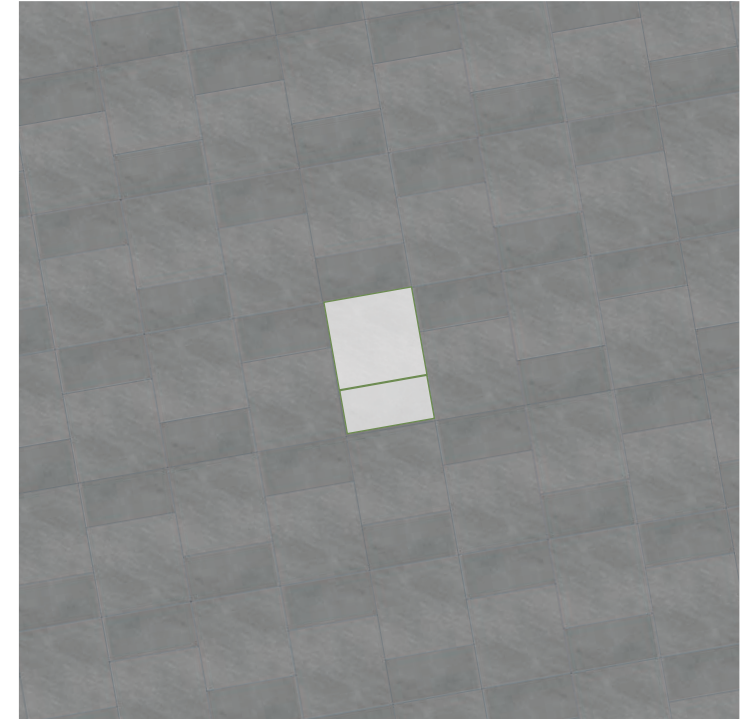

Module percentage

12"x24" = 67%
12"x12" = 33%

Available colors

- Bluestone Blue Select
- Bluestone Full color
- Thermal Bluestone Blue Select
- Thermal Bluestone Full Color
- Travertine Cross Cut White
- Travertine Cross Cut Cream
- Travertine Cross Cut Silver
- Limestone
- Michelangelo Extra White
- Arctic White
- African Beige
- Star Grey
- Indiana Buff Select
- Indiana Grey Select
- Indiana Variegated
- California Gold
- Rustic Gold
- Montauk White
- Montauk Grey
- Montauk Black
- Travertine Cross Cut Scabas
- Travertine Cross Cut Philadelphia
- Travertine Cross Cut Country Classic



Module percentage

12"x24" = 80%
12"x12" = 20%

Available colors

- Bluestone Blue Select
- Bluestone Full color
- Thermal Bluestone Blue Select
- Thermal Bluestone Full Color
- Travertine Cross Cut White
- Travertine Cross Cut Cream
- Travertine Cross Cut Silver
- Limestone
- Michelangelo Extra White
- Arctic White
- African Beige
- Star Grey
- Indiana Buff Select
- Indiana Grey Select
- Indiana Variegated
- California Gold
- Rustic Gold
- Montauk White
- Montauk Grey
- Montauk Black
- Travertine Cross Cut Scabas
- Travertine Cross Cut Philadelphia
- Travertine Cross Cut Country Classic



Module percentage

24"x24" = 50%
12"x24" = 50%

Available colors

- Bluestone Blue Select
- Bluestone Full color
- Thermal Bluestone Blue Select
- Thermal Bluestone Full Color
- Travertine Cross Cut White
- Travertine Cross Cut Cream
- Travertine Cross Cut Silver
- Limestone
- Michelangelo Extra White
- Arctic White
- African Beige
- Star Grey
- Vintage Slab
- Barge Gold
- Silver Quartz
- Diamond White
- Fashion Grey
- Indiana Buff Select
- Indiana Grey Select
- Indiana Variegated
- California Gold
- Rustic Gold
- Montauk White
- Montauk Grey
- Montauk Black
- Travertine Cross Cut Scabas
- Travertine Cross Cut Philadelphia
- Travertine Cross Cut Country Classic



Module percentage

24"x24" = 67%
12"x24" = 33%

Available colors

- Bluestone Blue Select
- Bluestone Full color
- Thermal Bluestone Blue Select
- Thermal Bluestone Full Color
- Travertine Cross Cut White
- Travertine Cross Cut Cream
- Travertine Cross Cut Silver
- Limestone
- Michelangelo Extra White
- Arctic White
- African Beige
- Star Grey
- Vintage Slab
- Barge Gold
- Silver Quartz
- Diamond White
- Fashion Grey
- Indiana Buff Select
- Indiana Grey Select
- Indiana Variegated
- California Gold
- Rustic Gold
- Montauk White
- Montauk Grey
- Montauk Black
- Travertine Cross Cut Scabas
- Travertine Cross Cut Philadelphia
- Travertine Cross Cut Country Classic



* Modular products with 6 mm joint (approx 1/4").

M.P.D. SMALL FIVE*



M.P.D. SMALL SIX*



M.P.D. SMALL SEVEN*

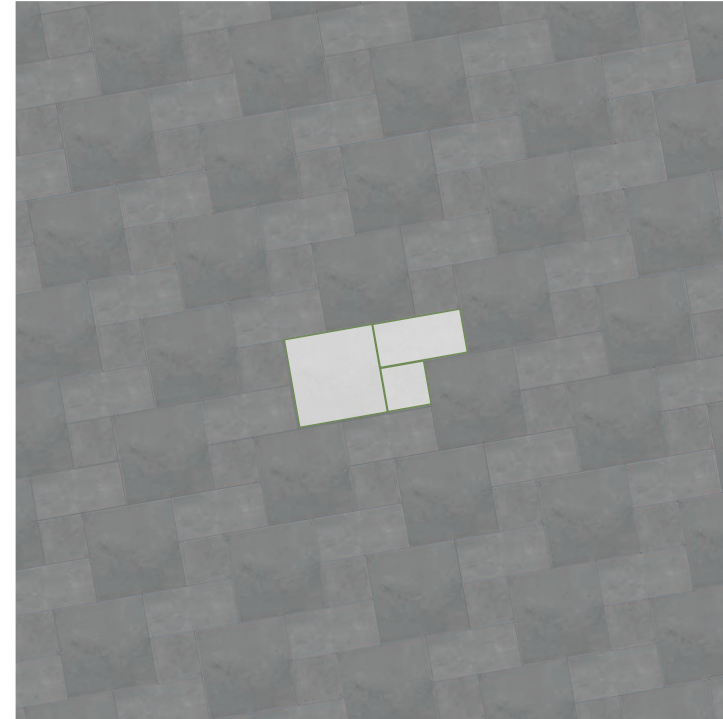

M.P.D. SMALL EIGHT*

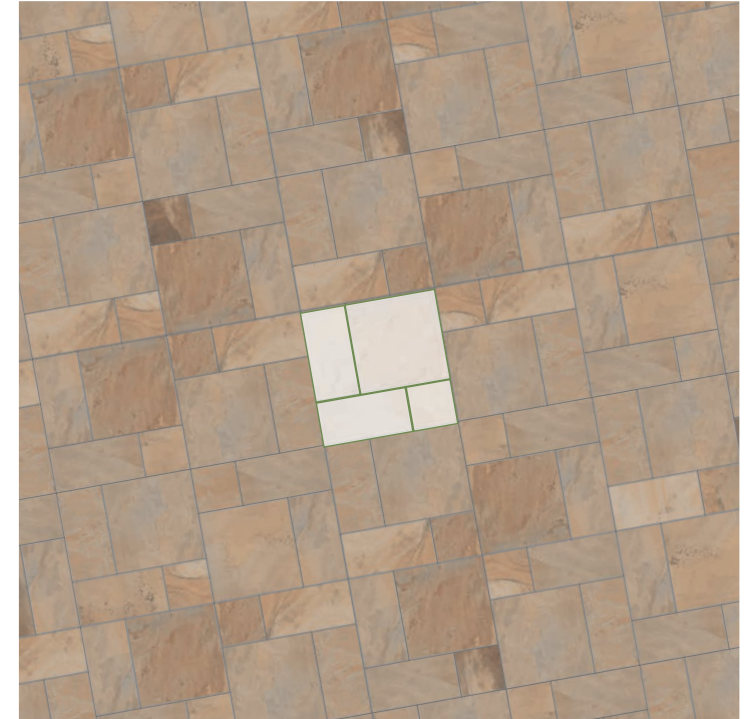

Module percentage

24"x24" = 57%
12"x24" = 29%
12"x12" = 14%

Available colors

- Bluestone Blue Select
- Bluestone Full color
- Thermal Bluestone Blue Select
- Thermal Bluestone Full Color
- Travertine Cross Cut White
- Travertine Cross Cut Cream
- Travertine Cross Cut Silver
- Limestone
- Michelangelo Extra White
- Arctic White
- African Beige
- Star Grey
- Indiana Buff Select
- Indiana Grey Select
- Indiana Variegated
- California Gold
- Rustic Gold
- Montauk White
- Montauk Grey
- Montauk Black
- Travertine Cross Cut Scabas
- Travertine Cross Cut Philadelphia
- Travertine Cross Cut Country Classic



Module percentage

24"x24" = 33%
12"x24" = 50%
12"x12" = 17%

Available colors

- Bluestone Blue Select
- Bluestone Full color
- Thermal Bluestone Blue Select
- Thermal Bluestone Full Color
- Travertine Cross Cut White
- Travertine Cross Cut Cream
- Travertine Cross Cut Silver
- Limestone
- Michelangelo Extra White
- Arctic White
- African Beige
- Star Grey
- Indiana Buff Select
- Indiana Grey Select
- Indiana Variegated
- California Gold
- Rustic Gold
- Montauk White
- Montauk Grey
- Montauk Black
- Travertine Cross Cut Scabas
- Travertine Cross Cut Philadelphia
- Travertine Cross Cut Country Classic

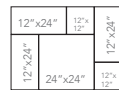

Module percentage

24"x24" = 57%
12"x24" = 29%
12"x12" = 14%

Available colors

- Bluestone Blue Select
- Bluestone Full color
- Thermal Bluestone Blue Select
- Thermal Bluestone Full Color
- Travertine Cross Cut White
- Travertine Cross Cut Cream
- Travertine Cross Cut Silver
- Limestone
- Michelangelo Extra White
- Arctic White
- African Beige
- Star Grey
- Indiana Buff Select
- Indiana Grey Select
- Indiana Variegated
- California Gold
- Rustic Gold
- Montauk White
- Montauk Grey
- Montauk Black
- Travertine Cross Cut Scabas
- Travertine Cross Cut Philadelphia
- Travertine Cross Cut Country Classic



Module percentage

24"x24" = 44%
12"x24" = 45%
12"x12" = 11%

Available colors

- Bluestone Blue Select
- Bluestone Full color
- Thermal Bluestone Blue Select
- Thermal Bluestone Full Color
- Travertine Cross Cut White
- Travertine Cross Cut Cream
- Travertine Cross Cut Silver
- Limestone
- Michelangelo Extra White
- Arctic White
- African Beige
- Star Grey
- Indiana Buff Select
- Indiana Grey Select
- Indiana Variegated
- California Gold
- Rustic Gold
- Montauk White
- Montauk Grey
- Montauk Black
- Travertine Cross Cut Scabas
- Travertine Cross Cut Philadelphia
- Travertine Cross Cut Country Classic



* Modular products with 6 mm joint (approx 1/4").

* Modular products with 6 mm joint (approx 1/4").

M.P.D. SMALL NINE*

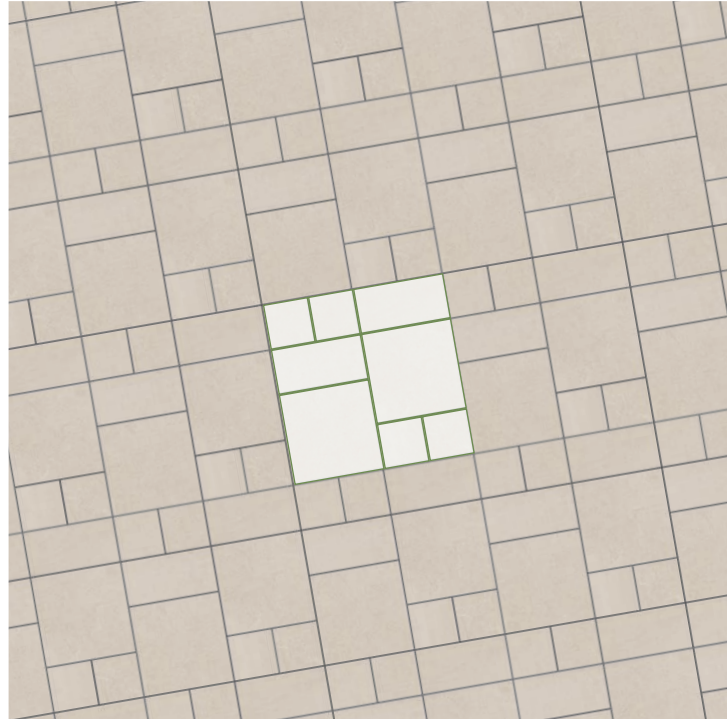

Module percentage

24"x24" = 50%
12"x24" = 25%
12"x12" = 25%

Available colors

- Bluestone Blue Select
- Bluestone Full color
- Thermal Bluestone Blue Select
- Thermal Bluestone Full Color
- Travertine Cross Cut White
- Travertine Cross Cut Cream
- Travertine Cross Cut Silver
- Limestone
- Michelangelo Extra White
- Arctic White
- African Beige
- Star Grey
- Indiana Buff Select
- Indiana Grey Select
- Indiana Variegated
- California Gold
- Rustic Gold
- Montauk White
- Montauk Grey
- Montauk Black
- Travertine Cross Cut Scabas
- Travertine Cross Cut Philadelphia
- Travertine Cross Cut Country Classic

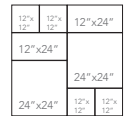

M.P.D. SMALL TEN*

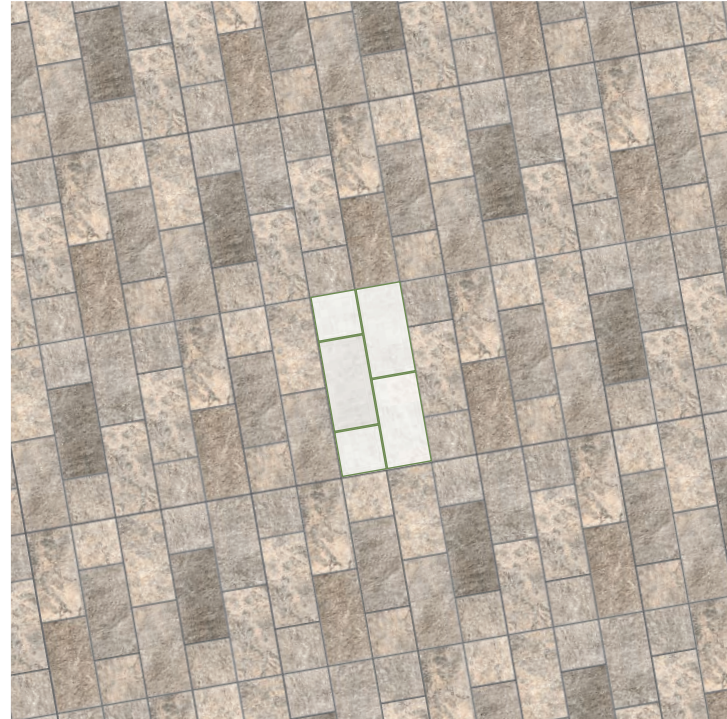

Module percentage

12"x24" = 75%
12"x12" = 25%

Available colors

- Bluestone Blue Select
- Bluestone Full color
- Thermal Bluestone Blue Select
- Thermal Bluestone Full Color
- Travertine Cross Cut White
- Travertine Cross Cut Cream
- Travertine Cross Cut Silver
- Limestone
- Michelangelo Extra White
- Arctic White
- African Beige
- Star Grey
- Indiana Buff Select
- Indiana Grey Select
- Indiana Variegated
- California Gold
- Rustic Gold
- Montauk White
- Montauk Grey
- Montauk Black
- Travertine Cross Cut Scabas
- Travertine Cross Cut Philadelphia
- Travertine Cross Cut Country Classic

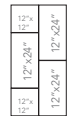

* Modular products with 6 mm joint (approx 1/4").



PROJECT

OUTDOOR FLOOR DESIGN
Frontier20 Travertine Cross Cut Silver - 24"x24"
Frontier20 Travertine Cross Cut Silver - 12"x24"
WALL DESIGN
Brick World Soho Black - 3"x12"

PRODUCT RANGE.

PROJECT

OUTDOOR FLOOR DESIGN

- Frontier20 Limestone - 24"x48"
- Frontier20 Limestone - 12"x48"
- Frontier20 Limestone - 12"x12"
- Frontier20 Limestone Grip Stair Tread - 12"x48"
- Frontier20 Limestone Riser - 6"x48"

WALL DESIGN

- Veneer World Pro Ledgestone Alpine Alaska - 6"x24"
- Frontier20 Limestone Wall Cover - 12"x24"

FLOWER BEDS DESIGN

- Veneer World Pro Ledgestone Ridge Black - 6"x24"

COLORED BODY PORCELAIN PAVERS - Rectified Monocaliber

BLUESTONE DESIGN PROJECT

THERMAL BLUESTONE
BLUE SELECT

AMERICANSTONE ★

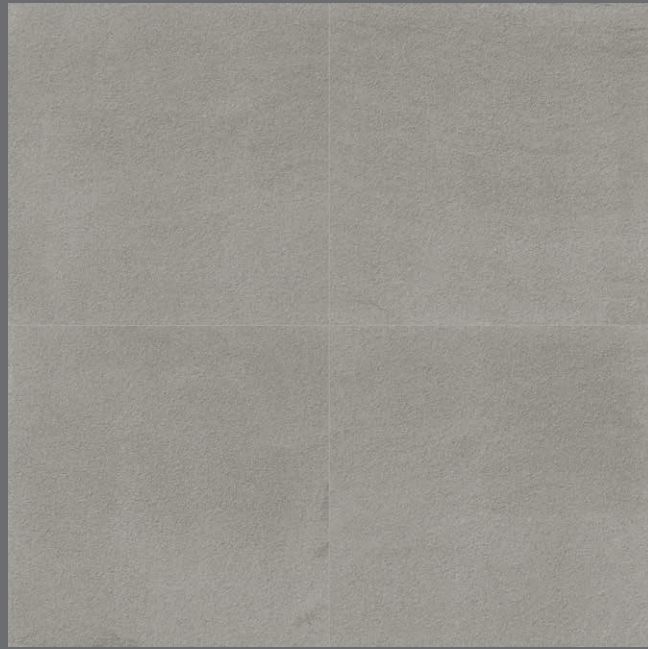

Available sizes

Color shading

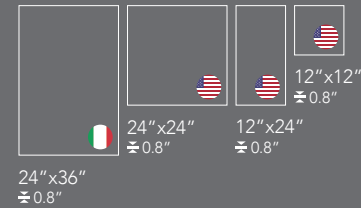

BLUESTONE BLUE SELECT

AMERICANSTONE ★



Available sizes

Color shading

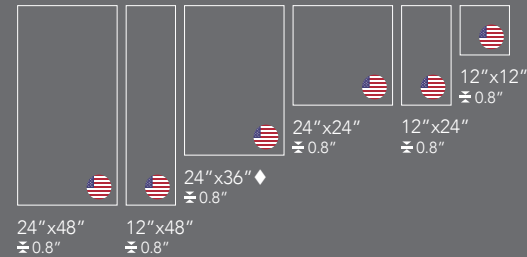

COLORED BODY PORCELAIN PAVERS - Rectified Monocaliber

BLUESTONE DESIGN PROJECT

THERMAL BLUESTONE
FULL COLOR

AMERICANSTONE ★



Available sizes

Color shading

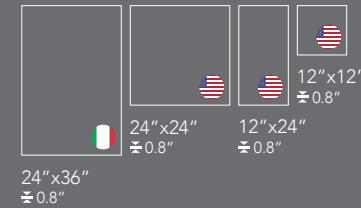

BLUESTONE FULL COLOR

AMERICANSTONE ★



Available sizes

Color shading

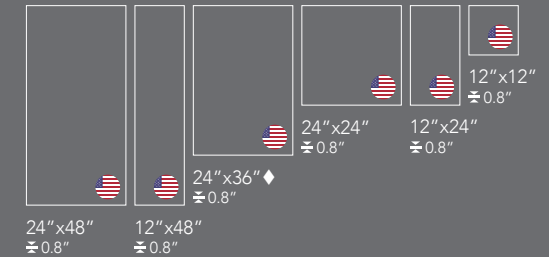

The color of pavers printed in this catalog may differ from actual pavers. Paver color reproductions in this catalog are representative only. Slight tone and shade variations are inherent in porcelain pavers. Before selecting a color, we recommend that you contact your local representative, who will provide you with a sample piece of the requested paver.

This porcelain paver product is manufactured with a V2/V3/V4 shade variation. Remember that the amount of color as well as the texture of each piece may vary from paver to paver. Inspect the product immediately upon delivery and select pavers from many boxes during installation to minimize and blend any possible color difference.

Color Shading



LIMESTONE LOOK

LIMESTONE

AMERICANSTONE ★



Available sizes

Color shading

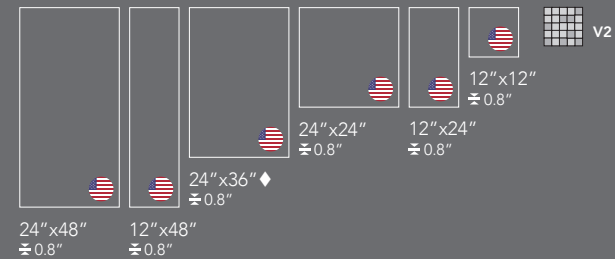

◆ NOTE: 24"x36" is sold as mix (24"x36" + 12"x24") along with 12"x24". The two sizes are palletized on the same pallet and sold together.

The color of pavers printed in this catalog may differ from actual pavers. Paver color reproductions in this catalog are representative only. Slight tone and shade variations are inherent in porcelain pavers. Before selecting a color, we recommend that you contact your local representative, who will provide you with a sample piece of the requested paver.

This porcelain paver product is manufactured with a V2 shade variation. Remember that the amount of color as well as the texture of each piece may vary from paver to paver. Inspect the product immediately upon delivery and select pavers from many boxes during installation to minimize and blend any possible color difference.

SLATE LOOK

VINTAGE SLAB

AMERICANSTONE ★

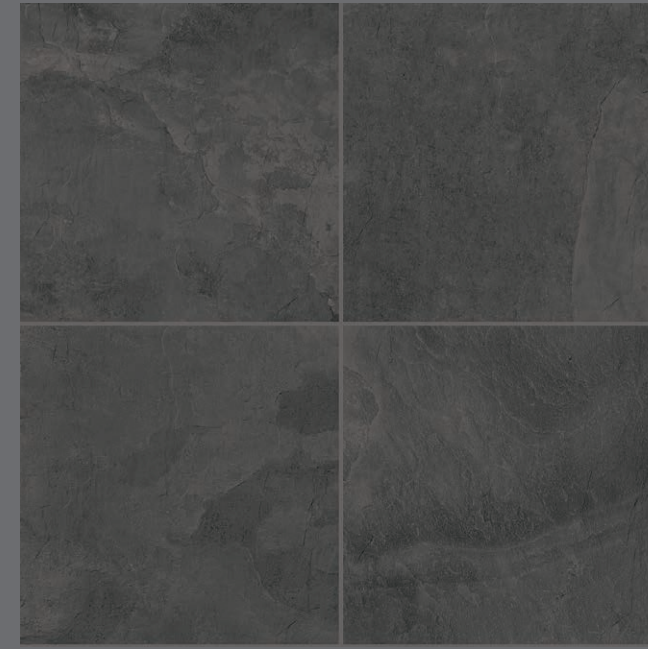

Available sizes

Color shading



Color Shading



SLATE DESIGN PROJECT

MONTAUK WHITE AMERICANSTONE ★



Available sizes Color shading

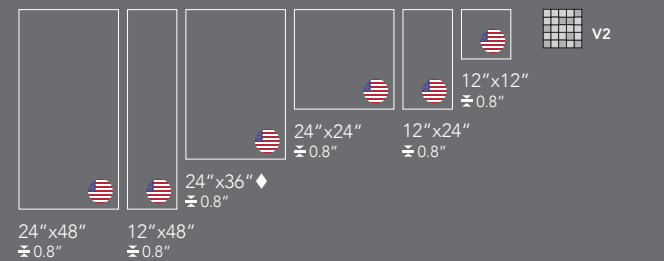

MONTAUK GREY AMERICANSTONE ★



Available sizes Color shading

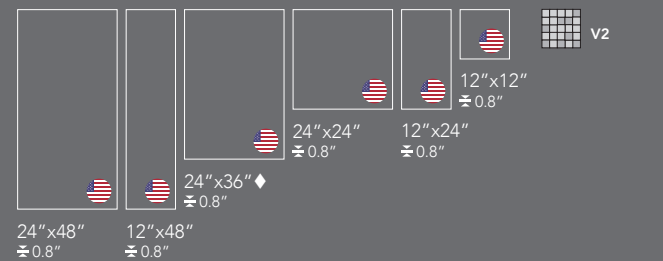

SLATE DESIGN PROJECT

MONTAUK BLACK AMERICANSTONE ★

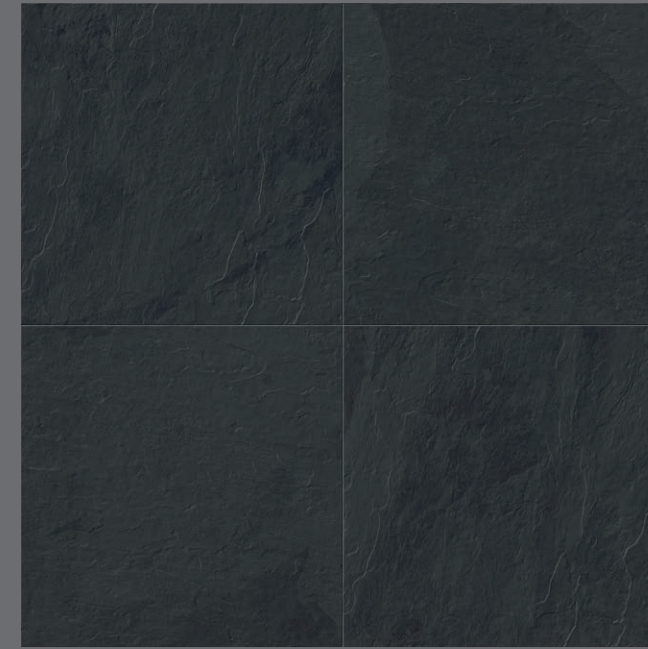

Available sizes Color shading

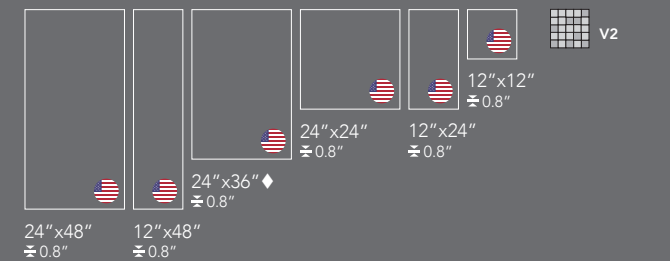

The color of pavers printed in this catalog may differ from actual pavers. Paver color reproductions in this catalog are representative only. Slight tone and shade variations are inherent in porcelain pavers. Before selecting a color, we recommend that you contact your local representative, who will provide you with a sample piece of the requested paver.

This porcelain paver product is manufactured with a V2 shade variation. Remember that the amount of color as well as the texture of each piece may vary from paver to paver. Inspect the product immediately upon delivery and select pavers from many boxes during installation to minimize and blend any possible color difference.

Color Shading



♦ NOTE: 24"x36" is sold as mix (24"x36" + 12"x24") along with 12"x24". The two sizes are palletized on the same pallet and sold together.

SLATE DESIGN PROJECT

CALIFORNIA GOLD

AMERICANSTONE ★



Available sizes

Color shading

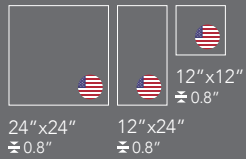

RUSTIC GOLD

AMERICANSTONE ★

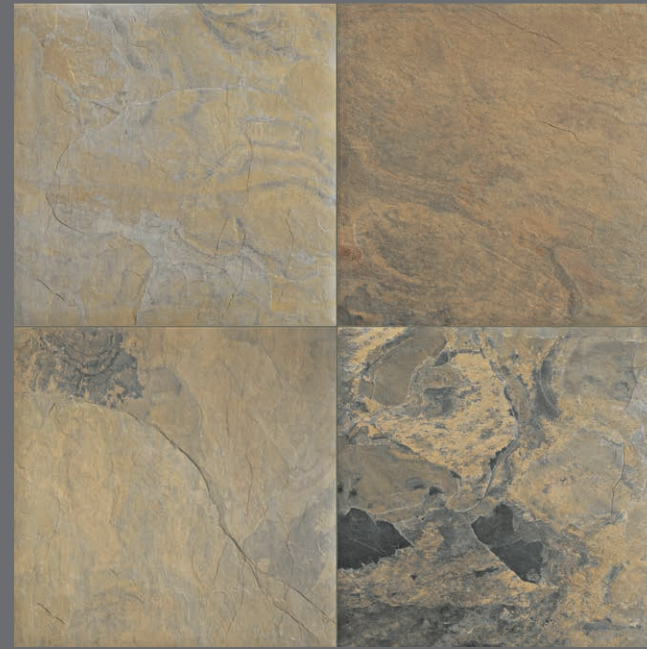

Available sizes

Color shading

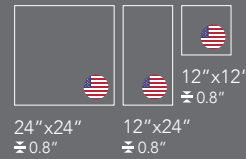

SLATE DESIGN PROJECT

MARIPOSA SLATE

AMERICANSTONE ★

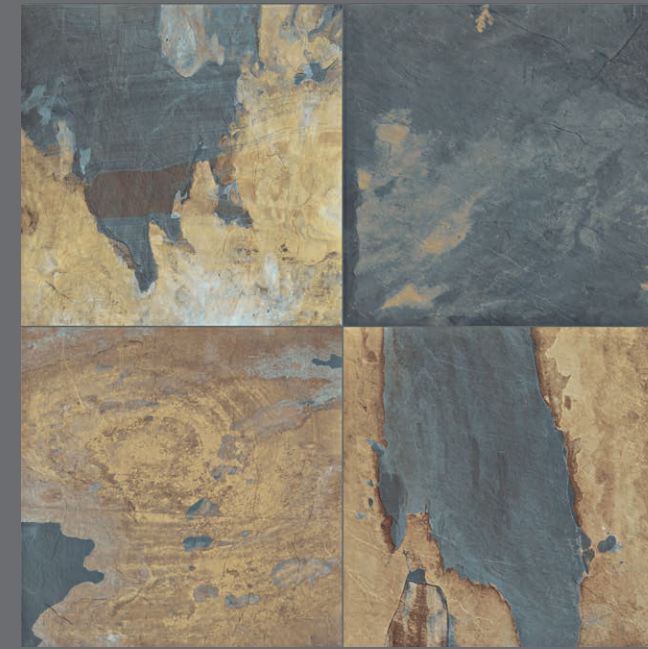

Available sizes

Color shading



PROJECT
OUTDOOR FLOOR DESIGN
 Frontier20 California Gold - 24"x24" - 12"x24" - 12"x12"
 Frontier20 California Gold Trim Pieces
 WALL DESIGN
 Essence Vibrant California Gold - 3"x12"

The color of pavers printed in this catalog may differ from actual pavers. Paver color reproductions in this catalog are representative only. Slight tone and shade variations are inherent in porcelain pavers. Before selecting a color, we recommend that you contact your local representative, who will provide you with a sample piece of the requested paver.

This porcelain paver product is manufactured with a V4 shade variation. Remember that the amount of color as well as the texture of each piece may vary from paver to paver. Inspect the product immediately upon delivery and select pavers from many boxes during installation to minimize and blend any possible color difference.

Color Shading



◆ NOTE: 24"x36" is sold as mix (24"x36" + 12"x24") along with 12"x24". The two sizes are palletized on the same pallet and sold together.

TRAVERTINE DESIGN PROJECT

TRAVERTINE SELECT
CROSS CUT PEARL

AMERICANSTONE ★



Available sizes

Color shading



24" x 24"
± 0.8"



V2

TRAVERTINE SELECT
CROSS CUT BEIGE

AMERICANSTONE ★



Available sizes

Color shading



24" x 24"
± 0.8"



V2

TRAVERTINE DESIGN PROJECT

TRAVERTINE VEIN CUT GREY

AMERICANSTONE ★



Available sizes

Color shading



24" x 48"
± 0.8"



V2

TRAVERTINE VEIN CUT BEIGE

AMERICANSTONE ★



Available sizes

Color shading



24" x 48"
± 0.8"



V2

Color Shading



V1
UNIFORM APPEARANCE



V2
SLIGHT VARIATION



V3
MODERATE VARIATION



V4
SUBSTANTIAL VARIATION

The color of pavers printed in this catalog may differ from actual pavers. Paver color reproductions in this catalog are representative only. Slight tone and shade variations are inherent in porcelain pavers. Before selecting a color, we recommend that you contact your local representative, who will provide you with a sample piece of the requested paver.

This porcelain paver product is manufactured with a V2 shade variation. Remember that the amount of color as well as the texture of each piece may vary from paver to paver. Inspect the product immediately upon delivery and select pavers from many boxes during installation to minimize and blend any possible color difference.

TRAVERTINE DESIGN PROJECT

TRAVERTINE
CROSS CUT SCABAS

AMERICANSTONE ★



Available sizes

Color shading

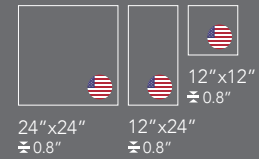

TRAVERTINE
CROSS CUT PHILADELPHIA

AMERICANSTONE ★



Available sizes

Color shading

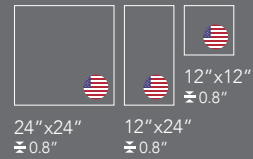

TRAVERTINE DESIGN PROJECT

TRAVERTINE
CROSS CUT COUNTRY CLASSIC

AMERICANSTONE ★



Available sizes

Color shading



PROJECT

OUTDOOR FLOOR DESIGN
Frontier 20 Travertine Cross Cut Country Classic - 12"x12" - 12"x24" - 24"x24"
OUTDOOR POOL DESIGN
Frontier20 Travertine Cross Cut Country Classic Trim Pieces

The color of pavers printed in this catalog may differ from actual pavers. Paver color reproductions in this catalog are representative only. Slight tone and shade variations are inherent in porcelain pavers. Before selecting a color, we recommend that you contact your local representative, who will provide you with a sample piece of the requested paver.

This porcelain paver product is manufactured with a V4 shade variation. Remember that the amount of color as well as the texture of each piece may vary from paver to paver. Inspect the product immediately upon delivery and select pavers from many boxes during installation to minimize and blend any possible color difference.

Color Shading



◆ NOTE: 24"x36" is sold as mix (24"x36" + 12"x24") along with 12"x24". The two sizes are palletized on the same pallet and sold together.

TRAVERTINE DESIGN PROJECT

TRAVERTINE CROSS CUT WHITE AMERICANSTONE ★

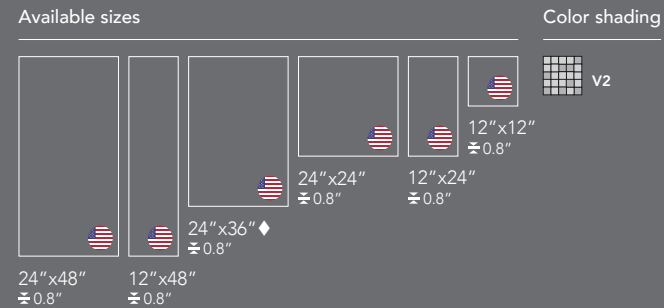

TRAVERTINE CROSS CUT SILVER AMERICANSTONE ★

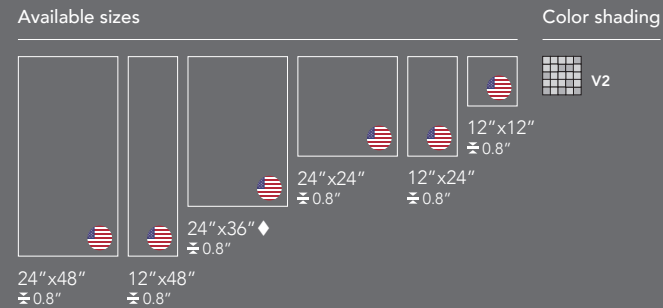

TRAVERTINE DESIGN PROJECT

TRAVERTINE CROSS CUT CREAM AMERICANSTONE ★

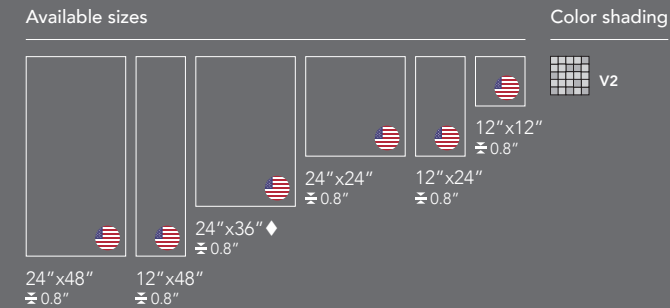

PROJECT
 OUTDOOR FLOOR DESIGN
 Frontier20 Travertine Cross Cut Cream - 24"x48" - 12"x48" - 24"x24" - 12"x24" - 12"x12"
 Frontier20 Travertine Cross Cut Cream Stair Tread - 12"x48"
 Frontier20 Travertine Cross Cut Cream Riser - 6"x48"

The color of pavers printed in this catalog may differ from actual pavers. Paver color reproductions in this catalog are representative only. Slight tone and shade variations are inherent in porcelain pavers. Before selecting a color, we recommend that you contact your local representative, who will provide you with a sample piece of the requested paver.

This porcelain paver product is manufactured with a V2 shade variation. Remember that the amount of color as well as the texture of each piece may vary from paver to paver. Inspect the product immediately upon delivery and select pavers from many boxes during installation to minimize and blend any possible color difference.



◆ NOTE: 24"x36" is sold as mix (24"x36" + 12"x24") along with 12"x24". The two sizes are palletized on the same pallet and sold together.

INDIANA SALEM DESIGN PROJECT

INDIANA BUFF SELECT

AMERICANSTONE ★



Available sizes

Color shading

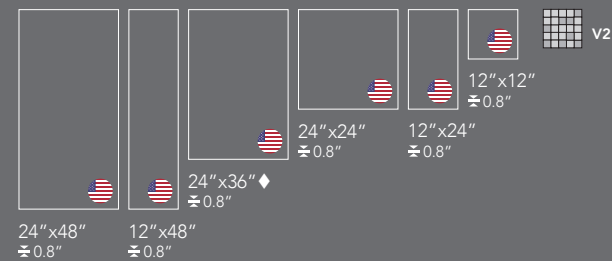

INDIANA GREY SELECT

AMERICANSTONE ★

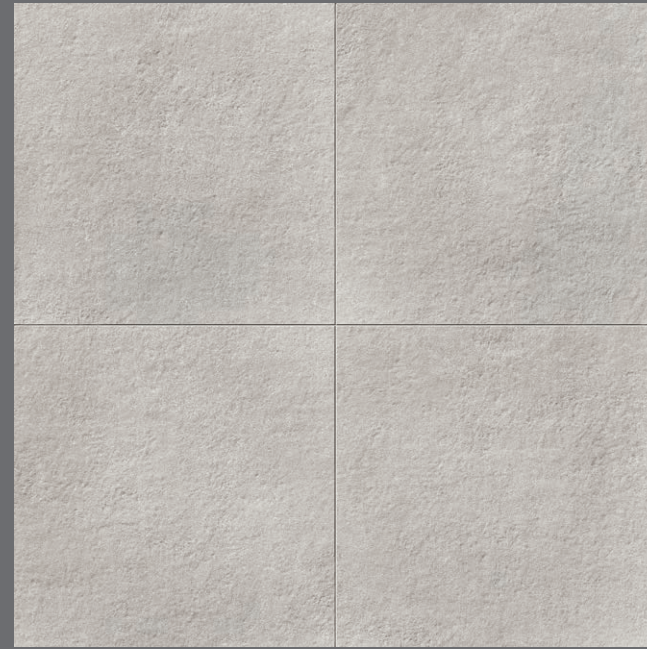

Available sizes

Color shading

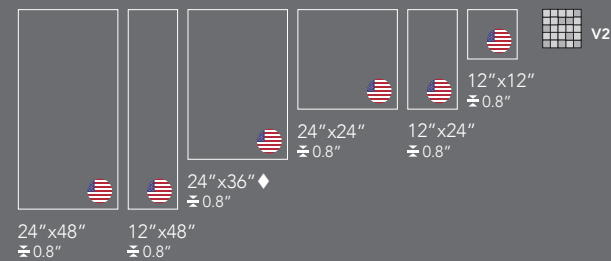

INDIANA SALEM DESIGN PROJECT

INDIANA VARIEGATED

AMERICANSTONE ★



Available sizes

Color shading



The color of pavers printed in this catalog may differ from actual pavers. Paver color reproductions in this catalog are representative only. Slight tone and shade variations are inherent in porcelain pavers. Before selecting a color, we recommend that you contact your local representative, who will provide you with a sample piece of the requested paver.

This porcelain paver product is manufactured with a V2/V3 shade variation. Remember that the amount of color as well as the texture of each piece may vary from paver to paver. Inspect the product immediately upon delivery and select pavers from many boxes during installation to minimize and blend any possible color difference.

Color Shading



◆ NOTE: 24"x36" is sold as mix (24"x36" + 12"x24") along with 12"x24". The two sizes are palletized on the same pallet and sold together.

COLORED BODY PORCELAIN PAVERS - Rectified Monocaliber

STONE LOOK

WHITE AVENUE

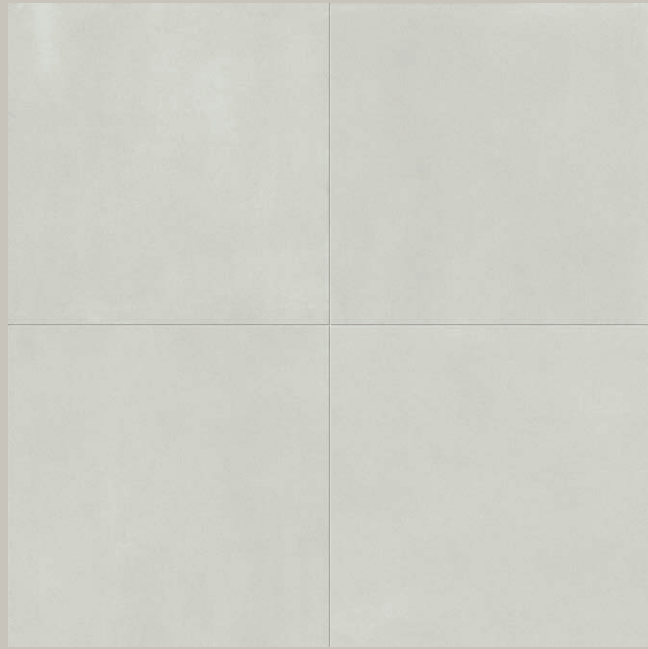

Available size

Color shading

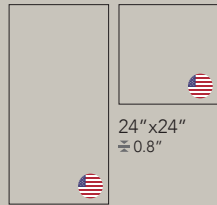

24" x 48"
± 0.8"

24" x 24"
± 0.8"

COSMOPOLITAN ASH

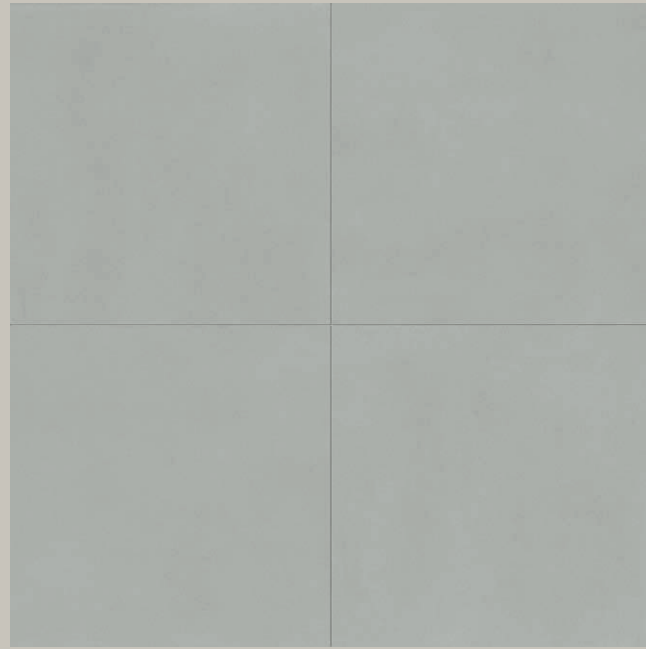

Available size

Color shading

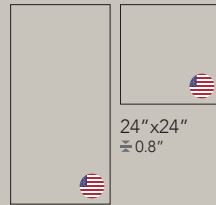

24" x 48"
± 0.8"

24" x 24"
± 0.8"

ARTISTIC BEIGE



Available size

Color shading



24" x 24"
± 0.8"

FASHION BLACK



Available size

Color shading

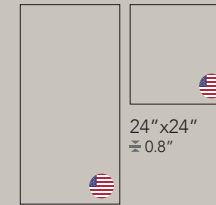

24" x 48"
± 0.8"

24" x 24"
± 0.8"

The color of pavers printed in this catalog may differ from actual pavers. Paver color reproductions in this catalog are representative only. Slight tone and shade variations are inherent in porcelain pavers. Before selecting a color, we recommend that you contact your local representative, who will provide you with a sample piece of the requested paver.

This porcelain paver product is manufactured with a V2 shade variation. Remember that the amount of color as well as the texture of each piece may vary from paver to paver. Inspect the product immediately upon delivery and select pavers from many boxes during installation to minimize and blend any possible color difference.

Color Shading



UNIFORM APPEARANCE



SLIGHT VARIATION



MODERATE VARIATION



SUBSTANTIAL VARIATION



TERRAZZO LOOK

DIAMOND WHITE

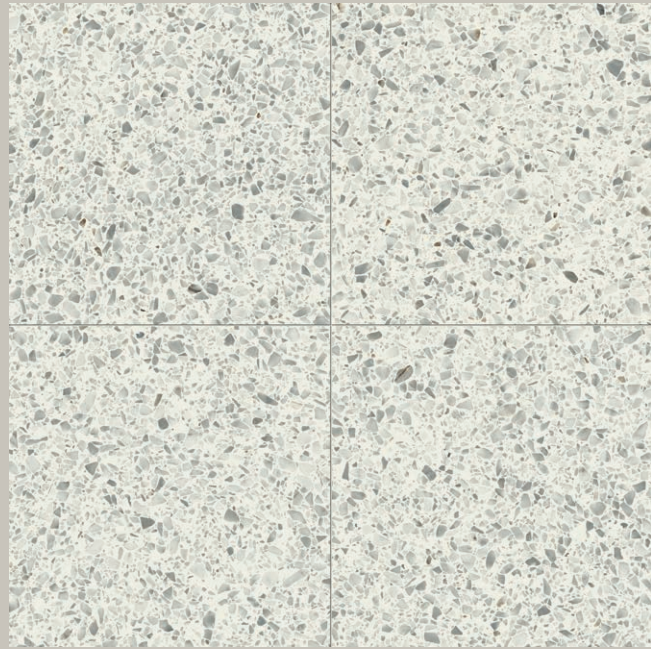

FASHION GREY

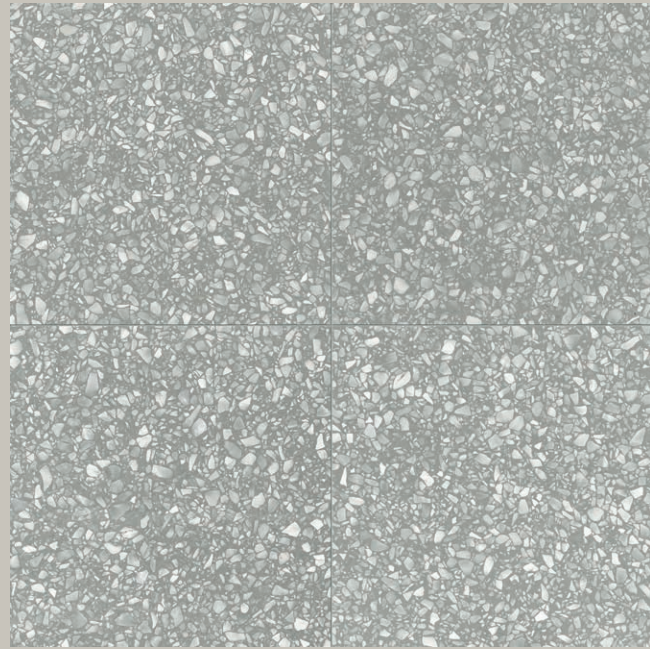

Available size

Color shading

Available size

Color shading



24"x24"
±0.8"

24"x24"
±0.8"

The color of pavers printed in this catalog may differ from actual pavers. Paver color reproductions in this catalog are representative only. Slight tone and shade variations are inherent in porcelain pavers. Before selecting a color, we recommend that you contact your local representative, who will provide you with a sample piece of the requested paver.

This porcelain paver product is manufactured with a V2 shade variation. Remember that the amount of color as well as the texture of each piece may vary from paver to paver. Inspect the product immediately upon delivery and select pavers from many boxes during installation to minimize and blend any possible color difference.

Color Shading

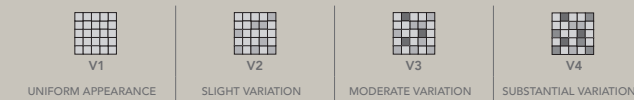

PROJECT

- OUTDOOR FLOOR DESIGN
 - Frontier20 Diamond White - 24"x24"
 - Frontier20 Fashion Grey - 24"x24"
 - Frontier20 Diamond White / Fashion Grey Stair Tread Rectified - 12"x24"
- OUTDOOR WALL DESIGN
 - Veneer World Urban LedgeStone White Mix - 6"x24"
 - Elite Fashion Grey - 24"x24"



COLORED BODY PORCELAIN PAVERS - Rectified Monocaliber

STONE LOOK

PATCHWORK WHITE



Available size



24" x 24"
± 0.8"

Matches with



White Avenue Precious Ivory Artistic Beige

Color shading



V3

The color of pavers printed in this catalog may differ from actual pavers. Paver color reproductions in this catalog are representative only. Slight tone and shade variations are inherent in porcelain pavers. Before selecting a color, we recommend that you contact your local representative, who will provide you with a sample piece of the requested paver.

This porcelain paver product is manufactured with a V3 shade variation. Remember that the amount of color as well as the texture of each piece may vary from paver to paver. Inspect the product immediately upon delivery and select pavers from many boxes during installation to minimize and blend any possible color difference.

STONE LOOK

PATCHWORK ASH



Available size



24" x 24"
± 0.8"

Matches with



Metro Grey Fashion Black Cosm. Ash

Color shading



V3

Color Shading



V1

UNIFORM APPEARANCE



V2

SLIGHT VARIATION



V3

MODERATE VARIATION



V4

SUBSTANTIAL VARIATION

FRONTIER20 - DECO

COLORED BODY PORCELAIN PAVERS - Rectified Monocaliber



STONE LOOK

PATCHWORK MIX



Available size



24" x 24"
± 0.8"

Matches with



Color shading



The color of pavers printed in this catalog may differ from actual pavers. Paver color reproductions in this catalog are representative only. Slight tone and shade variations are inherent in porcelain pavers. Before selecting a color, we recommend that you contact your local representative, who will provide you with a sample piece of the requested paver.

This porcelain paver product is manufactured with a V3 shade variation. Remember that the amount of color as well as the texture of each piece may vary from paver to paver. Inspect the product immediately upon delivery and select pavers from many boxes during installation to minimize and blend any possible color difference.

Color Shading



PROJECT

OUTDOOR FLOOR DESIGN
 Frontier20 Patchwork Mix - 24"x24"
 WALL DESIGN
 Masterplan Precious Ivory - 24"x48"

COLORED BODY PORCELAIN PAVERS - Rectified Monocaliber

QUARTZITE DESIGN PROJECT

ARCTIC WHITE



Available sizes

Color shading

AFRICAN BEIGE



Available sizes

Color shading

STAR GREY



Available sizes

Color shading



The color of pavers printed in this catalog may differ from actual pavers. Paver color reproductions in this catalog are representative only. Slight tone and shade variations are inherent in porcelain pavers. Before selecting a color, we recommend that you contact your local representative, who will provide you with a sample piece of the requested paver.

This porcelain paver product is manufactured with a V2 shade variation. Remember that the amount of color as well as the texture of each piece may vary from paver to paver. Inspect the product immediately upon delivery and select pavers from many boxes during installation to minimize and blend any possible color difference.

Color Shading

◆ NOTE: 24"x36" is sold as mix (24"x36" + 12"x24") along with 12"x24". The two sizes are palletized on the same pallet and sold together.

COLORED BODY PORCELAIN PAVERS - Rectified Monocaliber

QUARTZ LOOK

BARGE GOLD



Available sizes



24" x 24"
± 0.8" 12" x 24"
± 0.8"

Color shading



V3

SILVER QUARTZ



Available sizes



24" x 24"
± 0.8" 12" x 24"
± 0.8"

Color shading



V3

STONE LOOK

NATURAL IVORY



Available size



24" x 24"
± 0.8"

Color shading



V2

MODERN GREY



Available size



24" x 24"
± 0.8"

Color shading



V2

The color of pavers printed in this catalog may differ from actual pavers. Paver color reproductions in this catalog are representative only. Slight tone and shade variations are inherent in porcelain pavers. Before selecting a color, we recommend that you contact your local representative, who will provide you with a sample piece of the requested paver.

This porcelain paver product is manufactured with a V2/V3 shade variation. Remember that the amount of color as well as the texture of each piece may vary from paver to paver. Inspect the product immediately upon delivery and select pavers from many boxes during installation to minimize and blend any possible color difference.

Color Shading



V1

UNIFORM APPEARANCE



V2

SLIGHT VARIATION



V3

MODERATE VARIATION



V4

SUBSTANTIAL VARIATION

COLORED BODY PORCELAIN PAVERS - Rectified Monocaliber

CONCRETE LOOK

FREEDOM WHITE



Available size

Color shading



24" x 24"
± 0.8"



V2

PASSION SILVER



Available size

Color shading



24" x 24"
± 0.8"



V2

SIMPLY GREY



Available sizes

Color shading



24" x 24"
± 0.8"



V1



The color of pavers printed in this catalog may differ from actual pavers. Paver color reproductions in this catalog are representative only. Slight tone and shade variations are inherent in porcelain pavers. Before selecting a color, we recommend that you contact your local representative, who will provide you with a sample piece of the requested paver.

This porcelain paver product is manufactured with a V1/V2 shade variation. Remember that the amount of color as well as the texture of each piece may vary from paver to paver. Inspect the product immediately upon delivery and select pavers from many boxes during installation to minimize and blend any possible color difference.

Color Shading



V1

UNIFORM APPEARANCE



V2

SLIGHT VARIATION



V3

MODERATE VARIATION



V4

SUBSTANTIAL VARIATION







COLORED BODY PORCELAIN PAVERS - Rectified Monocaliber

MARBLE LOOK

MICHELANGELO EXTRA WHITE

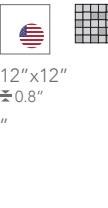

Available sizes

 24"x48" ±0.8"	 12"x48" ±0.8"	 24"x36" ±0.8"	 24"x24" ±0.8"	 12"x24" ±0.8"	 12"x12" ±0.8"
--	---	---	---	---	---

Color shading

 V2

◆ NOTE: 24"x36" is sold as mix (24"x36" + 12"x24") along with 12"x24". The two sizes are palletized on the same pallet and sold together.

The color of pavers printed in this catalog may differ from actual pavers. Paver color reproductions in this catalog are representative only. Slight tone and shade variations are inherent in porcelain pavers. Before selecting a color, we recommend that you contact your local representative, who will provide you with a sample piece of the requested paver.

This porcelain paver product is manufactured with a V2 shade variation. Remember that the amount of color as well as the texture of each piece may vary from paver to paver. Inspect the product immediately upon delivery and select pavers from many boxes during installation to minimize and blend any possible color difference.

LIMESTONE LOOK

INTERNATIONAL WHITE



MINIMALIST GREIGE

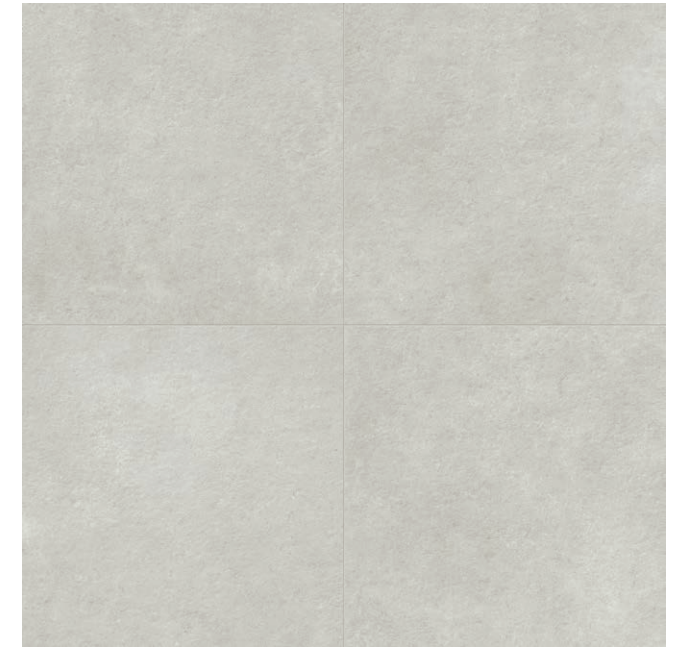

Available size

 24"x24" ±0.8"

Color shading

 V2





Available size

 24"x24" ±0.8"

Color shading

 V2

Color Shading

 V1 UNIFORM APPEARANCE	 V2 SLIGHT VARIATION	 V3 MODERATE VARIATION	 V4 SUBSTANTIAL VARIATION
---	---	---	--

COLORED BODY PORCELAIN PAVERS - Rectified Monocaliber

STONE LOOK

SKY



Available size



24" x 24"
± 0.8"

Color shading



V2

DESERT



Available size



24" x 24"
± 0.8"

Color shading



V2

ABSOLUTE



Available size



24" x 24"
± 0.8"

Color shading



V2

COSMOS



Available size



24" x 24"
± 0.8"

Color shading



V2

The color of pavers printed in this catalog may differ from actual pavers. Paver color reproductions in this catalog are representative only. Slight tone and shade variations are inherent in porcelain pavers. Before selecting a color, we recommend that you contact your local representative, who will provide you with a sample piece of the requested paver.

This porcelain paver product is manufactured with a V2 shade variation. Remember that the amount of color as well as the texture of each piece may vary from paver to paver. Inspect the product immediately upon delivery and select pavers from many boxes during installation to minimize and blend any possible color difference.

Color Shading



V1

UNIFORM APPEARANCE



V2

SLIGHT VARIATION



V3

MODERATE VARIATION



V4

SUBSTANTIAL VARIATION

COLORED BODY PORCELAIN PAVERS - Rectified Monocaliber

WOOD LOOK

SOUL WALNUT



Available size



12" x 48"
± 0.8"

Color shading



V2

SOUL GREY



Available size



12" x 48"
± 0.8"

Color shading



V2

The color of pavers printed in this catalog may differ from actual pavers. Paver color reproductions in this catalog are representative only. Slight tone and shade variations are inherent in porcelain pavers. Before selecting a color, we recommend that you contact your local representative, who will provide you with a sample piece of the requested paver.

This porcelain paver product is manufactured with a V2 shade variation. Remember that the amount of color as well as the texture of each piece may vary from paver to paver. Inspect the product immediately upon delivery and select pavers from many boxes during installation to minimize and blend any possible color difference.

WOOD LOOK

ESSENCE GREY



Available size



12" x 48"
± 0.8"

Color shading



V2

ESSENCE BROWN

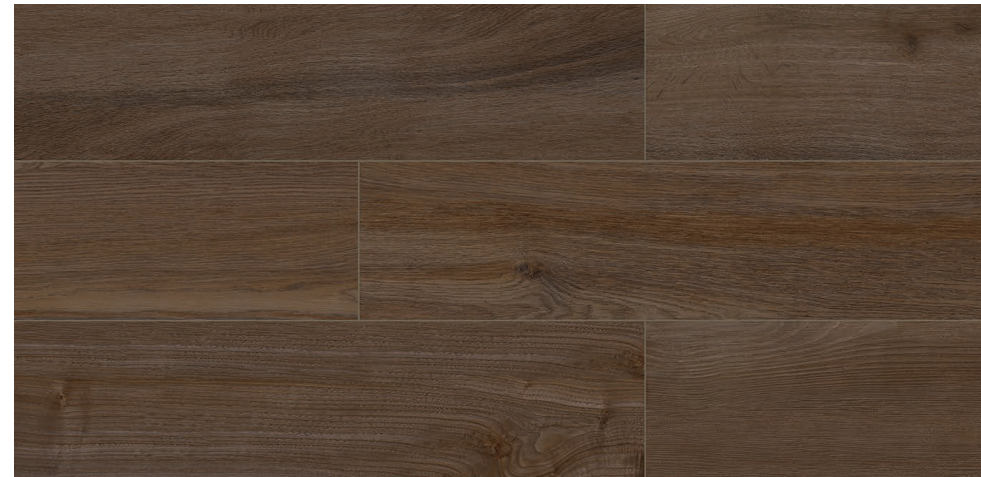

Available size



12" x 48"
± 0.8"

Color shading



V2

Color Shading



V1

UNIFORM APPEARANCE



V2

SLIGHT VARIATION



V3

MODERATE VARIATION



V4

SUBSTANTIAL VARIATION

FRONTIER20

COLORED BODY PORCELAIN PAVERS - Rectified Monocaliber

WOOD LOOK

WALNUT



Available size



24" x 24"
± 0.8"

Color shading



V3

PEPPER



Available size



24" x 24"
± 0.8"

Color shading



V3

The color of pavers printed in this catalog may differ from actual pavers. Paver color reproductions in this catalog are representative only. Slight tone and shade variations are inherent in porcelain pavers. Before selecting a color, we recommend that you contact your local representative, who will provide you with a sample piece of the requested paver.

This porcelain paver product is manufactured with a V3 shade variation. Remember that the amount of color as well as the texture of each piece may vary from paver to paver. Inspect the product immediately upon delivery and select pavers from many boxes during installation to minimize and blend any possible color difference.

Color Shading

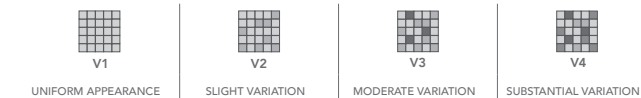

PROJECT

OUTDOOR FLOOR DESIGN
Frontier20 Essence Grey - 12"x48"

TRIM TILES TO LANDSCAPE THE OUTDOORS.

PROJECT

OUTDOOR FLOOR DESIGN

- Frontier20 Arctic White - 24"x48"
- Frontier20 Arctic White - 12"x48"
- Frontier20 Arctic White - 24"x24"
- Frontier20 Arctic White - 12"x24"
- Frontier20 Arctic White - 12"x12"
- Frontier20 Arctic White Grip Stair Tread Rectified - 12"x24"
- Frontier20 Arctic White Riser Rectified - 8"x24"

OUTDOOR POOL DESIGN

- Frontier20 Arctic White Linear Cover Drain Set - 24"x11.63"
- Frontier20 Arctic White Coping Rectified - 12"x24"

WALL DESIGN

- Veneer World Pro LedgeStone Ridge Black - 6"x24"
- Veneer World Pro LedgeStone Bluestone Tumbled - 6"x24"
- Vision Concrete - 24"x48"
- Vision Concrete - 12"x24"
- Vision Concrete - 24"x24"

FLOWER BED WALL DESIGN

- Veneer World Pro LedgeStone Tumbled - 6"x24"

Frontier20 includes a complete range of **special trim pieces** to seamlessly complete and accentuate the landscaping of outdoor spaces. The trim tiles represent the ideal solution for the planning of outdoor spaces, **commercially or residentially**. The special trims feature coordinated aesthetics to match those of the **Landmark porcelain paver**, for projects that demand **total visual continuity**.

DESTINATION OF USE.

- STAIRS
- POOLS
- WALL COVERS

PROJECT

FLOOR DESIGN
 Frontier20 Silver Quartz 24"x24"
 Frontier20 Silver Quartz Linear Cover Drain Set - 24"x24"
 Frontier20 Silver Quartz Coping - 24"x12"
 Frontier20 Silver Quartz Coping Corner - 24"x12"
 Frontier20 Silver Quartz Stair Tread - 24"x12"
 Frontier20 Silver Quartz Stair Tread Grip - 24"x12"
 Frontier20 Silver Quartz Riser - 24"x8"
 Frontier20 Silver Quartz Cover - 24"x12"
 Frontier20 Silver Quartz End Cover - 24"x12"

STAIR TREAD
P. 87

L SHAPE MITERED EDGE
P. 91

GRIP STAIR TREAD
P. 87

L SHAPE 2 SIDE CORNER CLOSURE
P. 91

RISER
P. 87

L SHAPE 45° CORNER
P. 90

COPING CORNER
P. 89

END COVER
P. 93

COVER
P. 93

LINEAR COVER DRAIN SET
P. 89

COPING
P. 89

L SHAPE MITERED EDGE
P. 90

STAIRS WITH AN IN-DEMAND AESTHETIC THAT IS ALSO HIGH PERFORMING.

SYSTEM.

- STAIR TREAD
- GRIP STAIR TREAD
- RISER

ADVANTAGES.

- RESISTANCE TO SALTS
- RESISTANCE TO CHEMICALS
- TECHNICAL PERFORMANCE
- ANTI-SLIP
- VISUAL CONTINUITY TO THE OUTDOOR FLOOR



COMFORT AND STYLE FOR SWIMMING POOL AREAS.

SYSTEM.

- LINEAR COVER DRAIN SET
- COPING
- COPING CORNER

ADVANTAGES.

- RESISTANCE TO SALTS
- RESISTANCE TO CHEMICALS
- ANTI-SLIPPERINESS
- DURABILITY
- EASY TO CLEAN
- VISUAL CONTINUITY TO THE OUTDOOR FLOOR

* The Linear Cover Drain Set is made-up of two pieces, each having a further beveled and polished edge. The two pieces are studied to be laid with the beveled and polished edges facing each other in order to create an open joint. See pages 45, 46 for more details.

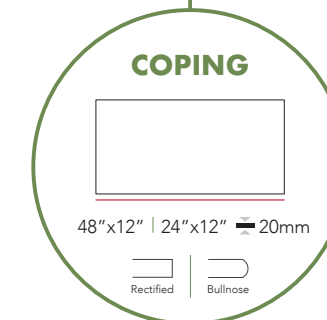
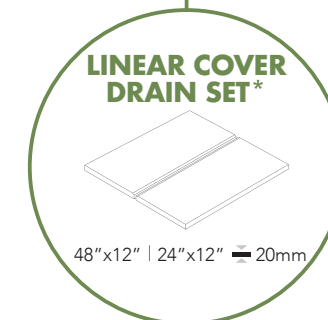
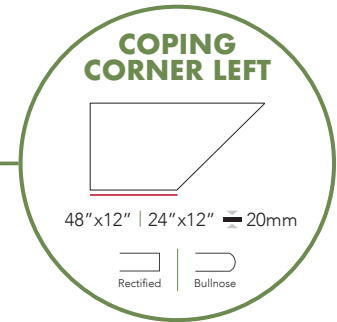
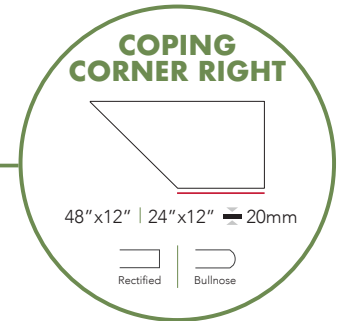
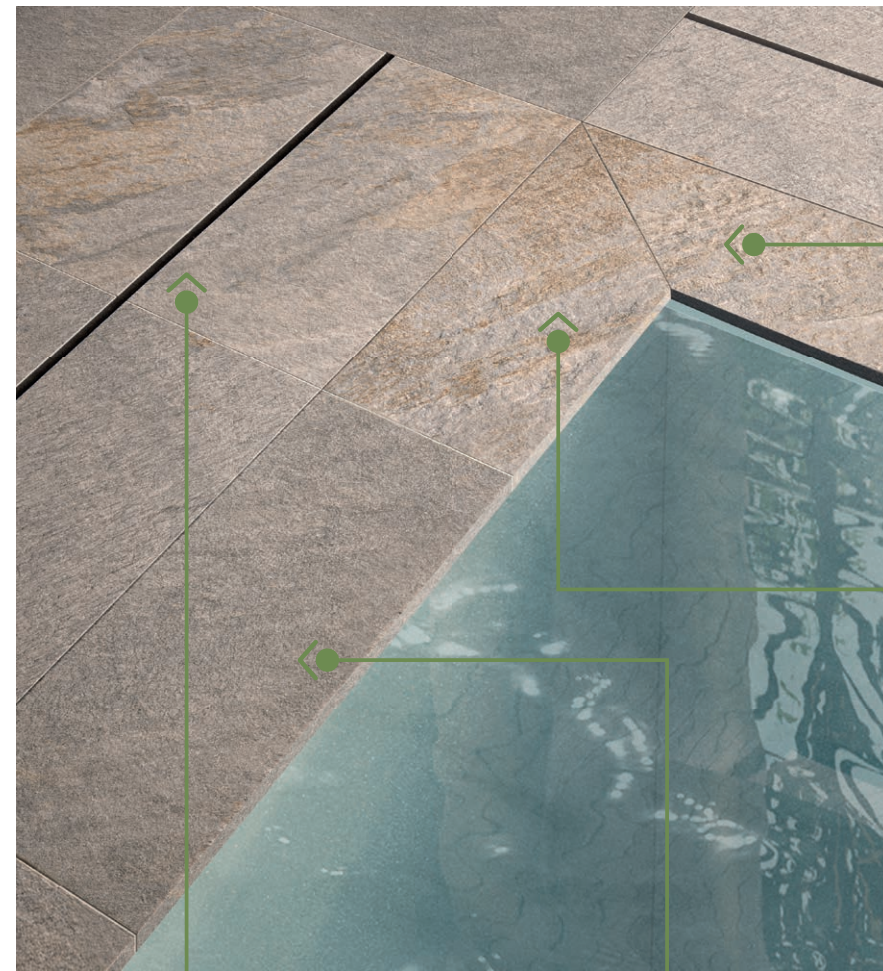

L SHAPE: A SLEEK, MODERN TWIST FOR POOLS AND STAIRS.

SYSTEM.

- L SHAPE MITERED EDGE
- L SHAPE CORNER CLOSURE

ADVANTAGES.

- RESISTANCE TO SALTS
- RESISTANCE TO CHEMICALS
- TECHNICAL PERFORMANCE
- ANTI-SLIP
- VISUAL CONTINUITY TO THE OUTDOOR FLOOR

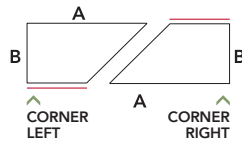
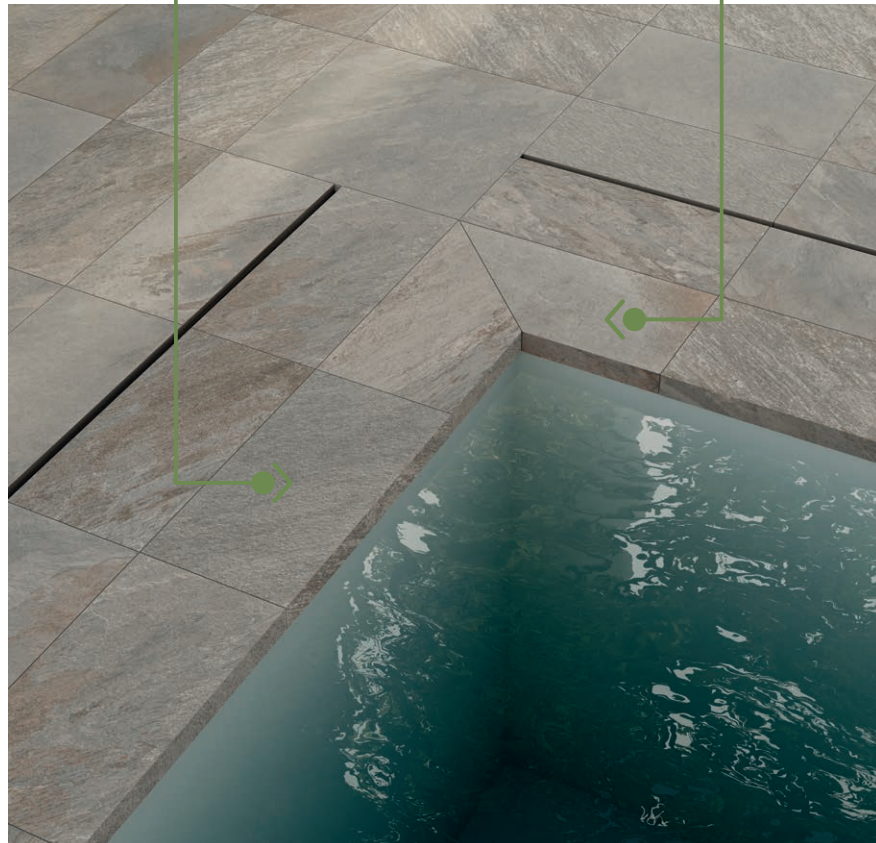

**L SHAPE
45° CORNER**

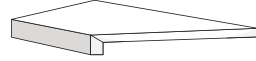

24"x12" 20mm

**L SHAPE
MITERED EDGE**

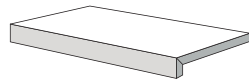

24"x12"

20mm

**L SHAPE
MITERED EDGE**

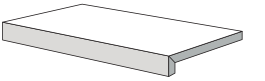

24"x12"

20mm

**L SHAPE
2 SIDE
CORNER CLOSURE**

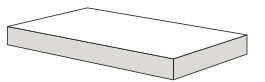

24"x12" 20mm

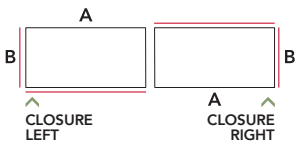

WALL COVERS: PROTECTION FROM WATER AND VISUAL CONTINUITY.

SYSTEM.

- COVER
- END-COVER

ADVANTAGES.

- ANTI-DETERIORATION
- EASY TO CLEAN
- PROTECTS THE WALL FROM WATER INFILTRATION

* Both Cover and End-Cover have dripstone and undecorated borders.



COVER*



12"x24"

20mm

END COVER*



12"x24"

20mm

DRIPSTONE

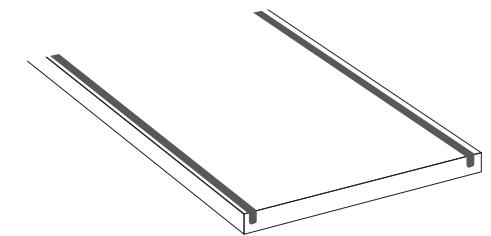

TECHNICAL INFORMATION.

PROJECT

OUTDOOR FLOOR DESIGN
Frontier20 Thermal Bluestone Full Color - 12"x24"
Frontier20 Thermal Bluestone Full Color - 24"x24"

INSTALLATION INFORMATION AND RECOMMENDATIONS.

ADDITIONAL RECOMMENDATIONS FOR THE INSTALLATION, ORDINARY CLEANING AND MAINTENANCE.

Landmark Ceramics recommends carrying out the procedures for the ordinary cleaning of Frontier20 floor surfaces using water and commercially available neutral detergents: the inclination of the surface and the space between adjacent slabs for dry-system installation favor the natural flow of water. However, it is important to take into consideration that any type of floor surface is subject to the surface tension effect of liquids: it is the same property of water that gives the tendency to transform into spherical droplets and which cause the curved top surface of a glass full of water. The surface tension can obstacle the complete drainage of water and cause a temporary stagnation of liquid on the slab edges. In order to avoid this problem, Landmark Ceramics recommends ensuring adequate inclination of the surface during installation so as to encourage the flow of water between adjacent slabs. Please remember in any case that, in view of the distinctive advantages of porcelain stoneware, Frontier20 absorbs practically no water, which makes it highly frost-proof. This may lead to localized water pooling, mainly on the edges of the pavers, independently of the manner and quality of the laying. Laying is also recommended with a minimum gap of 4 mm (5/32"). Should liquid deposit on the surface, it is recommended to push it towards grout lines using a brush or remove it with a wet and dry vacuum cleaner.

Specific details and instructions are given for each of the following installation options. Different climates and geographical locations will affect the thickness of the base. Depending on the location, contractors will lay the standard base thickness to install porcelain pavers for the needs of the area. When installing porcelain pavers, the bedding course sand must be pre-compacted and then struck off with a screed to the required thickness as shown in the drawings. Before the laying of the porcelain pavers, the sand layer underneath must be pre-compacted. The sand layer needs a 5 to 6% moisture content to insure a smooth strike off finish. **Compacting dry sand will not give the desired results.**

- Only use a paver saw with a wet cut porcelain blade to wet cut porcelain pavers.
- Before installing your porcelain pavers in sand set installations, pre-compact and strike off your sand leveling course.
- Plastic $\frac{3}{16}$ " (4 mm) spacers must always be used to install pavers on sand set and permeable installations.
- Never install pavers with porcelain to porcelain contact.
- The use of plate compactors is not recommended to be used on the porcelain pavers.

PORCELAIN PAVERS JOINT FILLING.

When installing porcelain paver on sand set base, fill the 4 mm (approx. $\frac{3}{16}$ ") paver joints with these options:

Traditional sand

Fill the open joints with traditional dry sand until completely filled. Sweep any excess sand off the pavers. Refilling of the joints with sand may be needed in the future due to wind and rain erosion.

Polymeric sand

Polymeric sand is a blend of polymers which harden when subjected to moisture. Sweep the sand into the open joints until completely filled. All excess sand and dust must be swept from the surface. Use a blower for the final dust removal to make certain all excess sand is removed. Any residual sand or dust can result in staining of the surface. Once the filling of the joints and the cleaning of the surface is complete, mist the pavement with water which activates the polymer and cures the mixture.

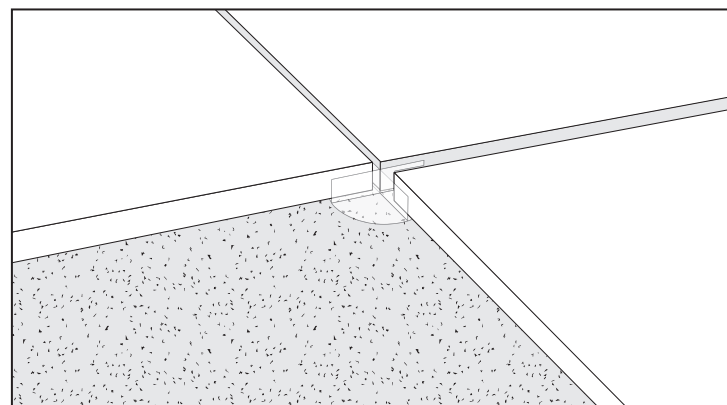

HANDLING AND SPECIALTY TOOLS.

Porcelain paver pallets are shipped with a very strong plastic covering and the individual units are packaged in protective cardboard boxes. The protective cardboard boxes guard them from the possibility of chipping. The handling of multiple loose stones can result in damaging or chipping of the pavers. Protect any un-used boxed pavers from the elements once the plastic shipping cover is removed. This insures the integrity of the protective cardboard boxes. Wet cut paver saw is used to cut paver accurately and cleanly to fit around edges and corners. The saw must be equipped with a diamond blade manufactured for wet cutting porcelain and designed to safely cut a 24" (60 cm) length porcelain paver. A paver clamp is used to easily handle the installation and removal of pavers. Gloves are highly recommended while handling and installing porcelain slabs to protect the hands from injury. Notched trowels and grout float tools for cementitious adhesive and grout installation. Follow the adhesive and grout manufacturer's recommendations to select the appropriate tools needed for application.

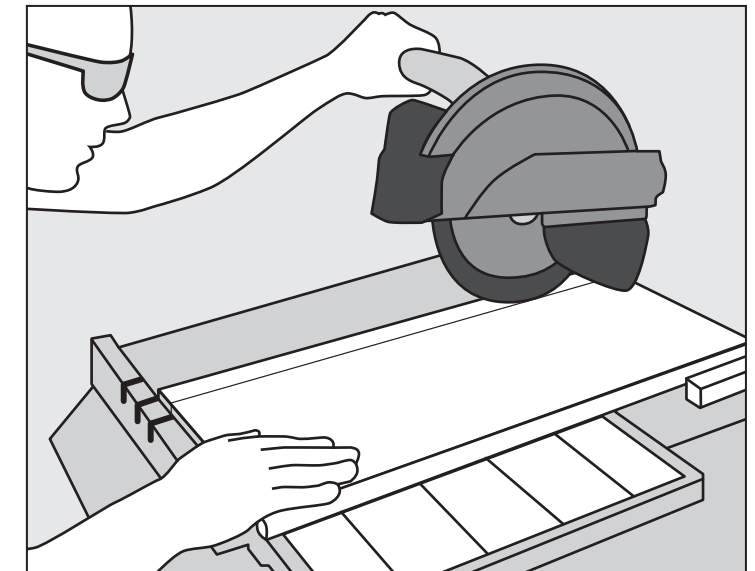
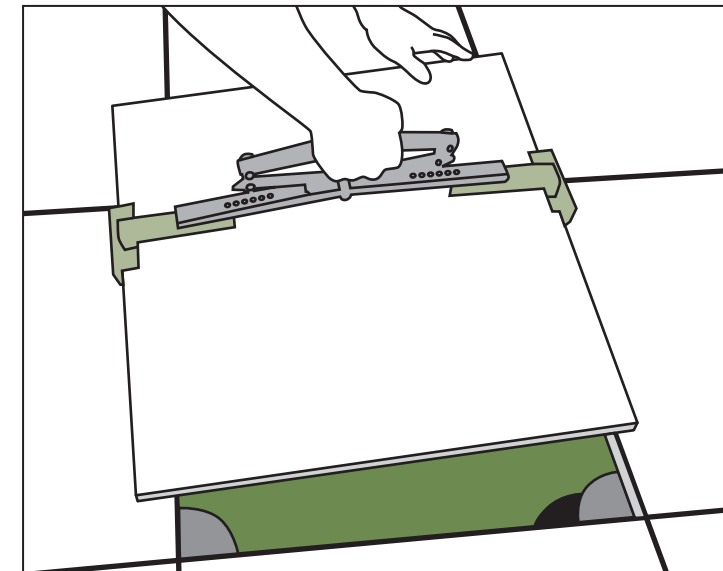

IMPORTANT NOTE: LEGAL DISCLAIMER

The nominal measurements include 4 mm (approx $\frac{3}{16}$ ") for product spacers which are sold separately. Although extreme care has been taken to ensure the accuracy of all measurements set forth herein, manufacturer assumes no liability relating thereto.

IMPORTANT NOTES:

1. Use the manufacturer's instructions when choosing polymeric sand for your project.
2. The use of cement blended sand and polymeric sand can reduce plant growth and insect infiltration within the joint infill material.
3. Whether using traditional sand or a cemented blended sand, ensure the gradation of the sand is fine enough to pass through and fill the joints.

LINEAR CUT.

The videos linked below show how to properly cut thick porcelain pavers (porcelain tiles with 20 mm thickness) currently used for outdoor installations. Cutting these porcelain thick pavers is very different than cutting standard thickness tiles. The extreme hardness of the material, combined with its thickness, are the main factors that will put cutting tools to the test. Based on the experience of many professional tile installers, what often happens is that the basic blades make one or two good cuts on very thick tiles and then lose their cutting power. This causes the diamond blade to be so ruined that it can't even be recovered with common abrasive stones. Many tile and brick installers have found a first solution for this: using segmented blades to cut these thicker tiles. These are more aggressive blades that easily cut this type of ceramics leaving though a very poor cutting finish. There is then the need to spend time after each cut to finish the cut edge of the tile, especially if it is going to be laid in a position that leaves that edge visible after installation. It is important that the cut is made using a professional wet saw cutting machine and that is it made by pushing (or pulling, depending on how the cutting saw is built) the blade parallel to the plane from the beginning of the cut, applying a horizontal force (**figure 1 and 2**) to the trolley while avoiding to push (or pull) with excessive force. **Please note that the cut has to be performed at once with one passage. It is very important to pull down the blade without touching the tile and then pull/push the disc to cut the entire paver all at once.**

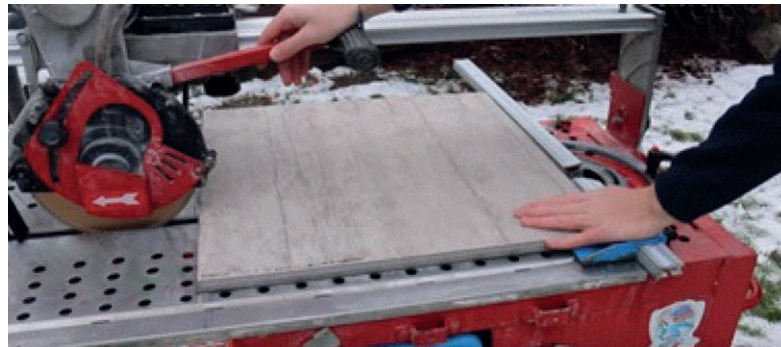

FIGURE 1



FIGURE 2

It is not recommended (figure 3) to carry out the cut by applying a force perpendicular to the side of the cutting plane (basically pushing down the saw into the tile). In fact, performing a vertical cut could affect the internal tensions of the product and lead to tile breakage.

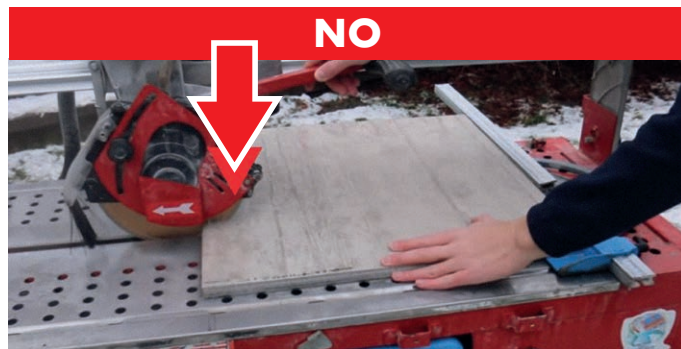

FIGURE 3

Another cutting method consists in making a groove about 2 / 3mm deep (**figure 4**) by applying a very light force perpendicular to the paver surface first and then making the final cut at once with one passage, as above reported in **figure 1 and 2**.



FIGURE 4

In both cases, it is always recommended to use high quality disc blades and to perform the revitalization operations of the latter whenever necessary to achieve a proper cut.

Landmark Ceramics recommends using a high quality blade specific for porcelain and revive it often. By using a low quality blade, or a blade not specifically made for porcelain, it might need to be revived 2 or even 3 times during the same cut. This can lead to extra costs related to the use of many diamond abrasive stones or, even worse, it can significantly increase the likelihood of breaking the paver during the cutting process.

During cutting, Landmark Ceramics always recommends the use of abundant water before, during, and after the cutting phases to minimize the presence or dispersion of ceramic powder and to cool down the blade.

Once the cut has been completed, Landmark Ceramics recommends to clean the newly cut surface with water, in order to remove all the dust from the paver created by the cutting operation.

Please find below some links to videos of 20 mm porcelain pavers cutting:

- https://www.youtube.com/watch?time_continue=2&v=rCK48yu8qV4
- https://www.youtube.com/watch?time_continue=3&v=A231KShJnww
- <https://www.youtube.com/watch?v=G6FVJz08ajA>
- <https://www.youtube.com/watch?v=FSMNtwxiLRI>

DRILLING HOLES WITH CORE BITS.

The creation of holes in traditional 9 / 10mm thick porcelain tile is a common practice, but it is very delicate and requires experience and technique. This is even more true for 20mm thick porcelain paver, being this particular tile thicker and more resistant.

To carry out this specific cut, it is recommended to use drills or grinders together with high quality core bits for porcelain tile and paver. The use of low quality core bits could cause numerous breakages, together with an extremely accelerated wear of the tool due to the resistance of the 20mm porcelain stoneware.

First of all, it is suggested to place the tile on a rigid support that absorbs the vibrations generated by the work (for example a panel of wood or regenerated rubber on a wooden panel).

After positioning the drill with the core bit in the desired position (remember to check that the drill is not in hammer mode) it is crucial to mark the exact point with a pencil, then proceed to place the core bit by tilting it slightly on the paver (**figure 5**).

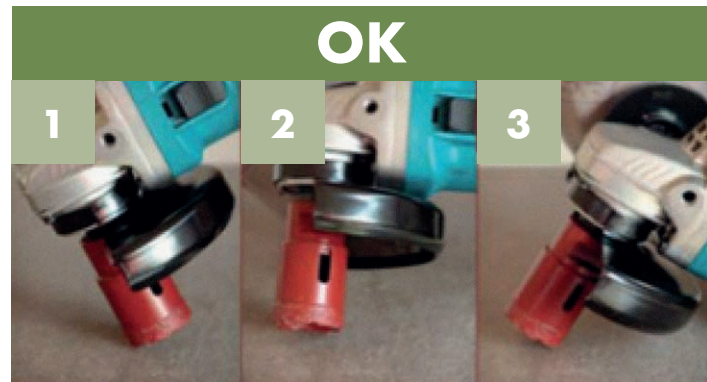

FIGURE 5



FIGURE 6

Do not place the core bit perpendicularly (**figure 6**) to the paver surface as it could lead to the breakage of the paver itself.

Once the core bit is in place and already moving, gently (and without pushing too much) make a continual and constant oscillatory movement until the hole from top to bottom through the paver is complete (**figure 5**).

Landmark Ceramics recommendation is to use a high quality core bit specific for porcelain.

By using a low quality core bit, or a core bit not specific for porcelain, the likelihood of breaking the paver during drilling operation could increase.

During drilling, Landmark Ceramics always recommends the use of abundant water before, during, and after the drilling phase to minimize the presence or dispersion of ceramic powder and to cool down the cutter.

Once the hole has been made, Landmark Ceramics recommends to clean the hole with water, in order to remove all the dust from the surface of the paver created by the drilling. It is also possible, whenever needed, to adjust the shape of the hole created with specific tools that soften the cut made by milling eventual sharp/irregular edges of the hole.

These tools are always made with artificial diamonds and should be specific for porcelain tiles and pavers.

Please find below a link to a video of 20 mm porcelain pavers drilling:

<https://www.youtube.com/watch?v=SVwzk894qdl>

GENERAL RECOMMENDATIONS.

Landmark Ceramics recommends using high quality tools and blades, specifically designed for porcelain. This is because 20mm thick porcelain is very strong and compact and does not behave, during cutting and drilling operations, like traditional thickness porcelain.

During cutting and/or drilling, Landmark Ceramics always recommends the use of abundant water before, during and after the drilling phases to minimize the presence or dispersion of ceramic powder and to cool the blade/core bit.

Landmark Ceramics also recommends to use certified wet or suction tools to reduce and minimize the dispersion of ceramic powder.

Once the necessary operations are finished, it is very important to clean the surface of the tile from the dust to prevent it from being trapped by the filler needed for the joints.

Landmark Ceramics always recommends the use of safety glasses, mask, gloves and steel toe shoes.

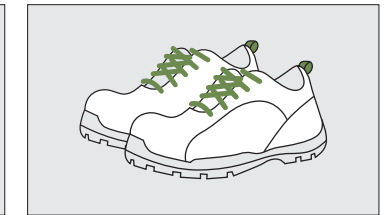
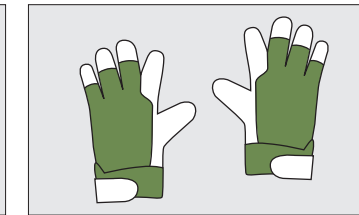
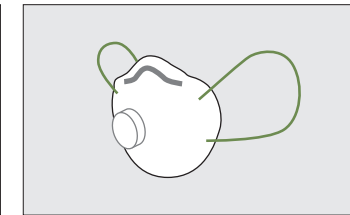
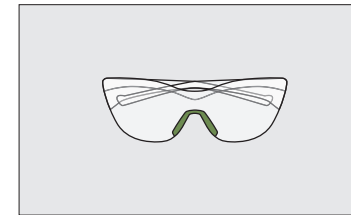

CLEANING INFORMATION FOR PORCELAIN PAVERS INSTALLED OVER CONCRETE

PORCELAIN PRODUCTS CARE AND MAINTENANCE

After any thin set installation of porcelain tile and pavers over concrete, best practices require to perform, after grouting, a first acid deep cleaning. For more information on how to perform a correct first cleaning after grouting, as well as on the right cleaning products to use, and ordinary maintenance of porcelain tiles and pavers once installed, we strongly recommend to refer to our Landmark cleaning guide. Alternatively, you can also see paragraph A, B and C here under. Failing to follow these instructions could lead to maintenance issues, most of the times derived from grout residues left on the surface of the tiles/pavers which create a film on the tiles/pavers surface itself that tends to retain dirt. If that occurs, the only way to possibly solve the issue is to perform a deep floor cleaning, using acid-based cleaners specific for porcelain and following a specific cleaning procedure described here under (See paragraph D). Please note that from time to time, depending on the type (cement-based vs epoxy), quantity and aging of the grout residue left on the tile/pavers surface, it could be really hard or even impossible to fully recover from the problem. That is why Landmark Ceramics highly suggests a first acid deep cleaning right after installing and grouting the tiles/pavers.

A) FIRST FLOOR DEEP CLEANING AFTER INSTALLATION

After Grouting the Joints (pic. 1) It is important to remove the excess grout with a sponge and clear water (pic. 2). After 12/48 hours, the grout in the joints will have "set up" / hardened significantly. There will be a noticeable residual "haze". Typically, a diluted acid cleaner specifically for removing "Grout Haze", combined with a soft scrubbing pad will remove the majority if not all the "Haze". Change your acid/water solution frequently for best results. It is also recommended to keep a bucket of clean water to remove the acid/water solution. It is recommended to keep and use clean dry towels to help remove as much residual water and keep the floor as dry as possible. Please refer to the cleaning chemical company's suggested methods and dilution rates. (pic. 3). For areas with excess grout or grout that becomes adhered to the face of the tile, further cleaning with an Acid/ Water Solution may be necessary. Please refer to the Cleaning Chemical Company's instructions as not all acids or chemicals are the same. The excess grout residue (pic. 4-5) must be removed so that it does not dry and stick on the surface. It is necessary to change the cleaning water frequently and rinse well. Care must be taken on inlaid, polished and especially Anti Slip products similar to Frontier20. The use of a floor-washing machine combined with the use of a diluted acid detergent helps reach the spaces between adjacent tiles and clean them properly. If such a cleaning procedure is not carried out, or if such cleaning is carried out too late, the grout residue creates an absorbent film, which holds dirt,

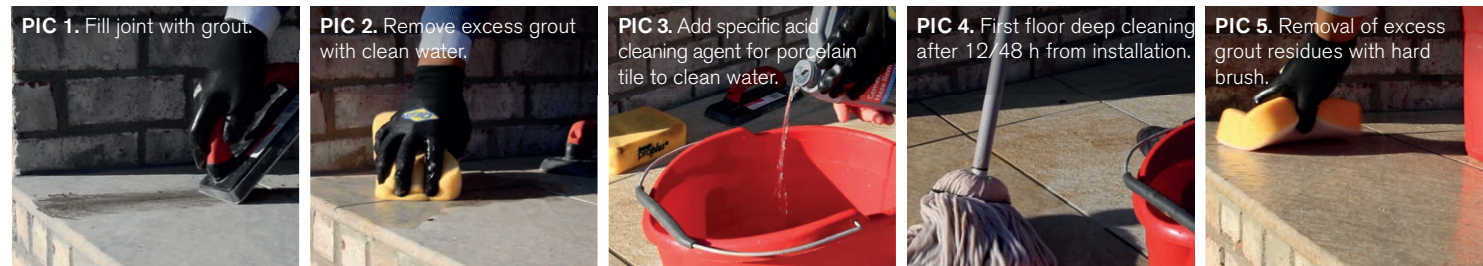

making the surface difficult to clean: in this case, Landmark Ceramics will not be liable for any damage caused to the surface.

B) DAY TO DAY CLEANING

After the post-laying cleaning operation has been thoroughly carried out, as far day to day cleaning we strongly advise against the use of waxes, oily soaps, impregnating products and various treatments (water and oil repellent) on the porcelain stoneware product, as their application is unnecessary. As is often the case in certain off the shelf detergents, they contain waxes and gloss inducing additives which, after various washes, can deposit a bright coat on the floor. Sometimes, even one drop of foods such as Coca Cola, water, wine etc. ...) is sufficient to eliminate this coat, restoring the tile's original appearance, a stain effect is produced in certain zones. In these cases, the floor must be de-waxed, using products to de-wax the applied waxes, following the producer's instructions. For films left by soap, lime scale, dirt, use an acid detergent, suitably diluted in water (read the product instructions carefully). It is also important to point out that Hydrofluoric acid (HF) and its derivatives can irredeemably damage porcelain stoneware. For routine cleaning, Landmark recommends the use of bleach or ammonia, suitably diluted in water; for polished porcelain

CLEANING AGENTS

TYPE OF STAIN	SOLUTION	DETERGENTS	MANUFACTURER
INORGANIC STAINS			
Cement Carbon Calcium Efflorescence Chalk Metallic residues Rust Cement-based grout Colored grout Wall paint	Acid	DETERGENT WITH AN ACID BASIS *	
		DETERDEK or similar	UNITED STATES > Fila Chemicals USA, Corp.10800 N.W. 21st Street #170 Miami, FL 33172 USA Tel. +1-305-513-0708 email filausa@filasolutions.com
		KERANET (liquid) or similar	MAPEI Americas Headquarters 1144 E. Newport Center Drive Deerfield Beach, Florida 33442
ORGANIC STAINS			
Coca Cola Ice Cream Coffee Wine Beer Animal fats Vegetable fats Mustard Mayonnaise Ketchup Jam Linseed oil Lipstick Wax	Alkaline and neutral	LIMITED FOAM TYPE PRODUCT **	
		PS87 or similar	UNITED STATES > Fila Chemicals USA, Corp.10800 N.W. 21st Street #170 Miami, FL 33172 USA Tel. +1-305-513-0708 email filausa@filasolutions.com
		FILACLEANER or similar	UNITED STATES > Fila Chemicals USA, Corp.10800 N.W. 21st Street #170 Miami, FL 33172 USA Tel. +1-305-513-0708 email filausa@filasolutions.com
		Ammonium	Universal
RESIDUAL RINGS of organic nature	Saline solution	Sodium hypochloride (bleach for white laundry)	Universal
Silicone oils Machine Oil Resins and glazes Coal and natural rubber Encres et feutres		FILASOLV or similar	UNITED STATES > Fila Chemicals USA, Corp.10800 N.W. 21st Street #170 Miami, FL 33172 USA Tel. +1-305-513-0708 email filausa@filasolutions.com
		Aceton	Universal
		NITRO - THINNER	Universal
		TURPENTINE	Universal
		TRICHLOROETHYLENE	Universal
		CIF AMMONIACAL	Universal
		HAND CLEANSER	Universal
Tire		Ice+scraper	
Silicone and chewin-gum		Ice+scraper	

N.B. When using the above products, the instructions on the package should be followed.

* **Detergent with an acid base:** a detergent with an acid basis, specifically recommended after bath floor or wall installation, for the decalciofiant cleaning and the regular maintenance.

** **Limited foam type product:** a limited foam type product degreasing and general cleaning, suitable for all types of stains but especially for remove of vegetable and animals fats.

CLEANING INFORMATION FOR PORCELAIN PAVERS INSTALLED OVER CONCRETE

stoneware, dry the floor after washing to prevent unsightly smudges. TIP: Since rinsing well with plenty of clean water is a fundamental part of the day to day cleaning procedure, Landmark advises against the use of products which state that they “do not need rinsing”

C) EXTRAORDINARY CLEANING

In the case of particular and/or particularly stubborn stains, we recommend using specific detergents as those indicated in chart here under reported.

It should furthermore not be forgotten that the removal of any type of stain is easier when the stain is still fresh. It is always important to test the detergents on a small area before applying to the entire surface, particularly in the case of porcelain stoneware with a lapped or polished finish

D) FLOOR DEEP CLEANING RECCOMANDATIONS TO BE USED IN CASE OF GROUT RESIDUES LEFT ON TILE/PAVERS SURFACE

1. Preliminary Cleaning Procedure: To begin with, it is important to clean the floor with a traditional detergent (Some examples of suitable detergents

you can consider are Deterdek from Fila, Keranet from Mapei) and rinse thoroughly in order to remove any dirt that is present on the tile/pavers aside from the grout left on them. This should be done carefully by following these steps:

- I. Clean the floor with water to remove dust and residues
- II. Apply an abundant quantity of detergent (such as the one pictured below) to clean the floor, following instructions provided on the detergent's bottle and making sure that, during the entire cleaning process, the detergent does not get in contact with grass or water of nearby swimming pools (if any)
- III. Brush strongly to remove the dirt (using a scotch-brite, ideally a motor-brush with scotch brite for big surfaces)
- IV. Rinse well with running water (it is recommend to use a vacuum cleaner to avoid burning the grass)
- V. Once well rinsed, dry the surface

2. Acidic Cleaning Procedure: Perform the acid cleaning procedure as indicated in the guide provided in the link above, hereunder summarized:

- I. Apply a professional acidic cleaner for grout haze on the floor. Some examples of suitable acidic cleaners you can consider are DETERDEK from Fila, KERANET from Mapei, or professional acidic cleaners like the one pictured below:
- II. Apply an abundant quantity of acidic cleaner on the entire floor, following instructions provided on the cleaner's bottle (for a better result, do not dilute with water), and making sure that, during the entire cleaning process, the cleaner (since it is an acid-based cleaner) does not get in contact with grass or water of nearby swimming pools (if any)
- III. Once applied, leave the product on the floor for about 20-30 minutes.
- IV. Brush strongly to remove the dirt (using a scotch brite, ideally a motor-brush with scotch brite for big surfaces). It is very important to apply a strong and prolonged mechanical action (tile by tile) on the floor while brushing. Please note that cleaning without a strong mechanical action (e.g. cleaning using a simple mop) is going to be useless and ineffective.
- V. Rinse the floor, making sure everything is absorbed, so that nothing will get in contact with grass or swimming pool water
- VI. Repeat everything from point “2.i.” as many times as necessary to achieve the desired result
- VII. Dry the floor's surface

E) ADDITIONAL NOTES & RECCOMANDATIONS

1. Please note that if the grouting was done well before the time of attempted cleaning, the grout residue left on the tile surface would have had time to settle and mature. In this case:

- It is particularly important, during the acid cleaning process, to let the acid settle in on the floor for a few minutes before brushing, so that the acid can soften the grout.
- It is also crucial to brush the tiles using the right tools and to apply on the floor a strong and prolonged mechanical action (tile by tile).
- It is very likely that a single deep acid cleaning will not be sufficient. In this case, it will be necessary to repeat the operation several times in order to eliminate all the grout residues. Keep in mind that the grout residue might not be immediately visible when the floor is clean, but can only be seen when the grout gets dirty. Therefore, even if the floor may appear clean after the first deep cleaning process, it could still have grout residue left on the surface of tile/pavers, that will get visible once they'll get dirty again. If that is the case, it will be necessary to repeat the deep cleaning procedure more than once until reaching a satisfactory result.

2. While performing the deep cleaning process, please be aware of any surrounding grass (making sure that the acid cleaner does not get in contact with it).

3. In case a deep cleaning is needed around a pool, make sure that during the entire cleaning process the acid cleaner does not get in contact with the water of the swimming pool.

4. Never use sealers of any kind on the surface of the porcelain tiles and pavers. Sealers are unnecessary and, furthermore, sealing will change the D.C.O.F. (Dynamic Co-efficient of Friction) of the pavers, resulting in a surface that will become more slippery. Furthermore, since Porcelain has such a low absorption rate, the sealer will unlikely stick and will most likely come off over time.

5. Bright colored products, in particular white and extra-white tiles, are very delicate and, although for all intent and purpose are hygienically clean, However, they can get dirty more easily than darker tiles. It is therefore necessary to remember that these particular products require careful regular maintenance.

WARNINGS

The above suggestions are a result of research, laboratory tests and several years' experience. However, the cleaning features of the materials may vary significantly according to the different installation methods, conditions of use, types of surface and destination. As a general rule, the higher the anti-slip values of the tiles are, the greater cleaning inconveniences may arise. The professional operator in charge of maintenance and cleaning shall always check the surface condition before proceeding with any cleaning and/or maintenance operation (we would suggest to test some tiles before installation). Landmark Ceramics declines any liability with reference to cleaning and maintenance operations in case of heavy conditions of use (such as mechanical workshop or spaces presenting oily residues or tire marks), bad installation work or wrong cleaning operations. It is agreed that Landmark Ceramics shall not be liable for any event, damage or defect due to wrong installation of the tiles, faulty cleaning and maintenance operations or inadequate choice of the type of material to be laid or of the adhesives used in a certain destination of use.

PORCELAIN PAVERS: ADDITIONAL RECOMMENDATIONS FOR THE INSTALLATION, ORDINARY CLEANING AND MAINTENANCE.

Landmark Ceramics recommends carrying out the procedures for the ordinary cleaning of Frontier20 floor surfaces using water and commercially available neutral detergents: the inclination of the surface and the space between adjacent slabs for dry-system installation favor the natural flow of water. However, it is important to take into consideration that any type of floor surface is subject to the surface tension effect of liquids: it is the same property of water that gives the tendency to transform into spherical droplets and which cause the curved top surface of a glass full of water. The surface tension can obstacle the complete drainage of water and cause a temporary stagnation of liquid on the slab edges. In order to avoid this problem, Landmark Ceramics recommends ensuring adequate inclination of the surface during installation so as to encourage the flow of water between adjacent slabs. Please remember in any case that, in view of the distinctive advantages of porcelain stoneware, Frontier20 absorbs practically no water, which makes it highly frost-proof. This may lead to localized water pooling, mainly on the edges of the pavers, independently of the manner and quality of the laying. Laying is also recommended with a minimum gap of 4 mm (5/32”). Should liquid deposit on the surface, it is recommended to push it towards grout lines using a brush or remove it with a wet and dry vacuum cleaner.

PERFORMANCE COMPARISON PORCELAIN PAVERS VS. COMPETITOR OUTDOOR PAVING MATERIALS

FEATURES	LANDMARK FRONTIER20 PORCELAIN PAVERS	WOOD PAVERS	CLAY BRICK	CIP (CAST IN PLACE) CONCRETE	CONCRETE PAVERS	NATURAL STONE
Stainable	No	Yes	Yes (Highly)	Yes	Yes	Yes (Highly)
Freeze Thaw Proof	Yes	No	No	No	No	No
Salt Resistant	Yes	No	Salt Will Degrade	No	No	No
Acid Resistant	Yes	No	Acid Will Burn	No	No	No
Scratch Resistant	Highly	No	Somewhat	No	No	No
Moisture Absorption	< 0,5%	Highly Varried	5%	5%	5-10%	≥ 5%
Easy To Repair	Yes	Yes	No	Can Not	No	No
Uv Resistant	Unaffected	No	Yes	If Sealed	Yes/No	Unaffected
Needs Sealed	Never	Yes	Recommended	Recommended	Recommended	Recommended
Pressure Washer Safe	> 1500 PSI	No	Not Recommended	> 1500 PSI	No	No
Environmentally Friendly	Facility 98% Green	Many Exotic Rainforest Species	No	Large Carbon Foot Print	Possible Fly Ash Content	Mined Or Imported
Recycled Content	5% In Each Paver	No	Not Possible	Not Possible	If Possible Less Than 5%	Not Possible

PHYSICAL PROPERTIES	TEST ASTM	NORTH AMERICAN STANDARD A137.3*	RESULTS
Water absorption *	C373	≤ 0.5%	COMPLY WITH ANSI A137.3
DCOF Average dynamic coefficient of friction **	ANSI A.326.3	As reported	EW - Exterior, Wet
Skid Resistance	EN 16165 (EX DIN 51097)	-	A+B+C
	EN 16165 (EX DIN 51130)		R11
Resistance to freeze/thaw cycling *	C1026	As reported	RESISTANT
Resistance to thermal shock	C484	As reported	RESISTANT
Warpage (edge)	C485	Warpage ± 0.4% or ± 0.05 in	COMPLY WITH ANSI A137.3
Warpage (diagonal)	C485	Warpage ± 0.4% or ± 0.07 in	COMPLY WITH ANSI A137.3
Wedging	C502	± 0.25% or ± 0.03 in	COMPLY WITH ANSI A137.3
Chemical resistance	C650	As reported	UNAFFECTED
Resistance to stain	C1378	As reported	UNAFFECTED
Thickness	C499	Range: 0.04 in	COMPLY WITH ANSI A137.3
Breaking strength	C1050	2000 lbf	COMPLY WITH ANSI A137.3
Module of Rupture	C1050	5000 psi	COMPLY WITH ANSI A137.3

* Average values referred to our production and related to the matt finish of the product.

** As far as values relating to the matt finish of the product and to tests carried out by certified external laboratories whose results are available upon request at Headoffice, we are willing to check the lot you are interested in purchasing.

- Be sure to use pavers belonging to the same caliber.

- Test results are available on request.

- The information provided can be subject to change. Please refer to one of our websites (lcsa.com or outdoor.landmarkceramics.com) for the latest, most accurate and up-to-date information.

WARNINGS.

- Outdoor pavings installed unglued above the ground level are subject to the action of the wind, with the risk, in some cases, of becoming airborne. The manufacturer recommends to require the assistance of a qualified professional in order to check the suitability of the installation system above the ground adopted, in accordance with the local laws and regulations and the conditions of use. Failure to do so could result in serious injury or property damage.
- If the application of the 20 mm slabs requires the ceramic product used in structural installations, the project engineer and/or customer must carefully assess the project requirements with regard to the technical specifications of the slabs. To prevent the risk of damage or injury, the manufacturer recommends: with regard to a raised floor installation a ceramic slab may fracture on impact if a heavy object falls on it from any significant height. Therefore the manufacturer recommends to check the specific intended use before starting the installation and to follow table for raised installation provided below. In certain conditions, reinforcing must be applied on the back of the slabs (double fiberglass mesh) supplied and applied by the manufacturer; with reference to any dry installation system of flooring above the ground level, the manufacturer recommends to comply with local regulations and conditions of use with regard to wind-load, loadbearing, seismic events, etc. Failure to comply with these recommendations may lead to improper use of the product and could cause serious damage or injury. Failure to adhere to the manufacturer's instructions for installation of slabs on raised pedestal systems may result in serious injury.
- For further information and recommendations concerning the installation systems please refer to outdoor.landmarkceramics.com website.





 **LANDMARK**
CERAMICS



 **LANDMARK**
CERAMICS

Landmark Ceramics - UST, Inc.

1427 N. Main Street
Mount Pleasant, TN 38474

Tel. 931.325.5700

outdoor.landmarkceramics.com

LEARN MORE ABOUT

